



MRS1104C-111011

MRS1000

3D LIDAR SENSORS

SICK
Sensor Intelligence.





Ordering information

Type	Part no.
MRS1104C-111011	1081208



Detailed technical data

Features

Measurement principle	HDDM ⁺
Application	Outdoor
Light source	Infrared (850 nm)
Laser class	1 (IEC 60825-1:2014, EN 60825-1:2014)
Aperture angle	Horizontal 275° Vertical 7.5° (Over 4 measurement levels)
Scanning frequency	50 Hz, 4 x 12.5 Hz
Angular resolution	0.25°
Heating	No
Working range	0.2 m ... 64 m
Scanning range	At 10% remission 16 m At 90% remission 30 m
Spot size	10.4 mrad x 8.7 mrad
Amount of evaluated echoes	3

Mechanics/electronics

Electrical connection	M12 round connectors (D-coded, aligned) with swivel connector
Supply voltage	10 V ... 30 V
Power consumption	≤ 13 W, Start-up phase max. 30 W for 1 s
Housing	AIMG4,5
Housing color	Gray (RAL 7042)
Enclosure rating	IP65, IP67 (IEC 60529:1989+AMD1:1999+AMD2:2013)
Protection class	III
Weight	1.2 kg
Dimensions (L x W x H)	151.9 mm x 150 mm x 92.5 mm

Performance

Scan/frame rate	55,000 measurement point/s ... 165,000 measurement point/s
Response time	4 layers, typ. 20 ms ¹⁾ 1 layer, typ. 80 ms
Systematic error	± 60 mm
Statistical error	≤ 30 mm
Integrated application	Integrated field evaluation with flexible fields on 4 levels, Data output
Number of field sets	Up to 64 fields
Simultaneous evaluation cases	Up to 16 evaluations
Filter	Fog filter Particle filter Average filter Median filter Ground reference evaluation

¹⁾ Depending on the selected filter settings and the object size.

Interfaces

Ethernet	✓, TCP/IP, UDP/IP
Function	Host, OPC, NTP, Measured data output (distance, RSSI)
Data transmission rate	10/100 MBit/s
Digital inputs and outputs	I/O (8 (Multiport))
Optical indicators	LEDs
Configuration software	SOPAS ET Web server (display)

Ambient data

Object remission	2 % ... > 1,000 % (Reflector)
Electromagnetic compatibility (EMC)	EN 61000-6-2:2005-08 EN 61000-6-4 (2007-01) + A1 (2011)
Vibration resistance	IEC 60068-2-6:2007
Shock resistance	IEC 60068-2-27:2008
Ambient operating temperature	-30 °C ... +50 °C
Storage temperature	-40 °C ... +75 °C
Ambient light immunity	80 klx

General notes

Note on use	The sensor does not constitute a safety component as defined by relevant legislation on machine safety.
--------------------	---

Classifications

ECl@ss 5.0	27270990
ECl@ss 5.1.4	27270990
ECl@ss 6.0	27270913
ECl@ss 6.2	27270913
ECl@ss 7.0	27270913
ECl@ss 8.0	27270913
ECl@ss 8.1	27270913
ECl@ss 9.0	27270913

MRS1104C-111011 | MRS1000

3D LIDAR SENSORS

ETIM 5.0	EC002550
ETIM 6.0	EC002550
UNSPSC 16.0901	46171620



Dimensional drawing (Dimensions in mm (inch))

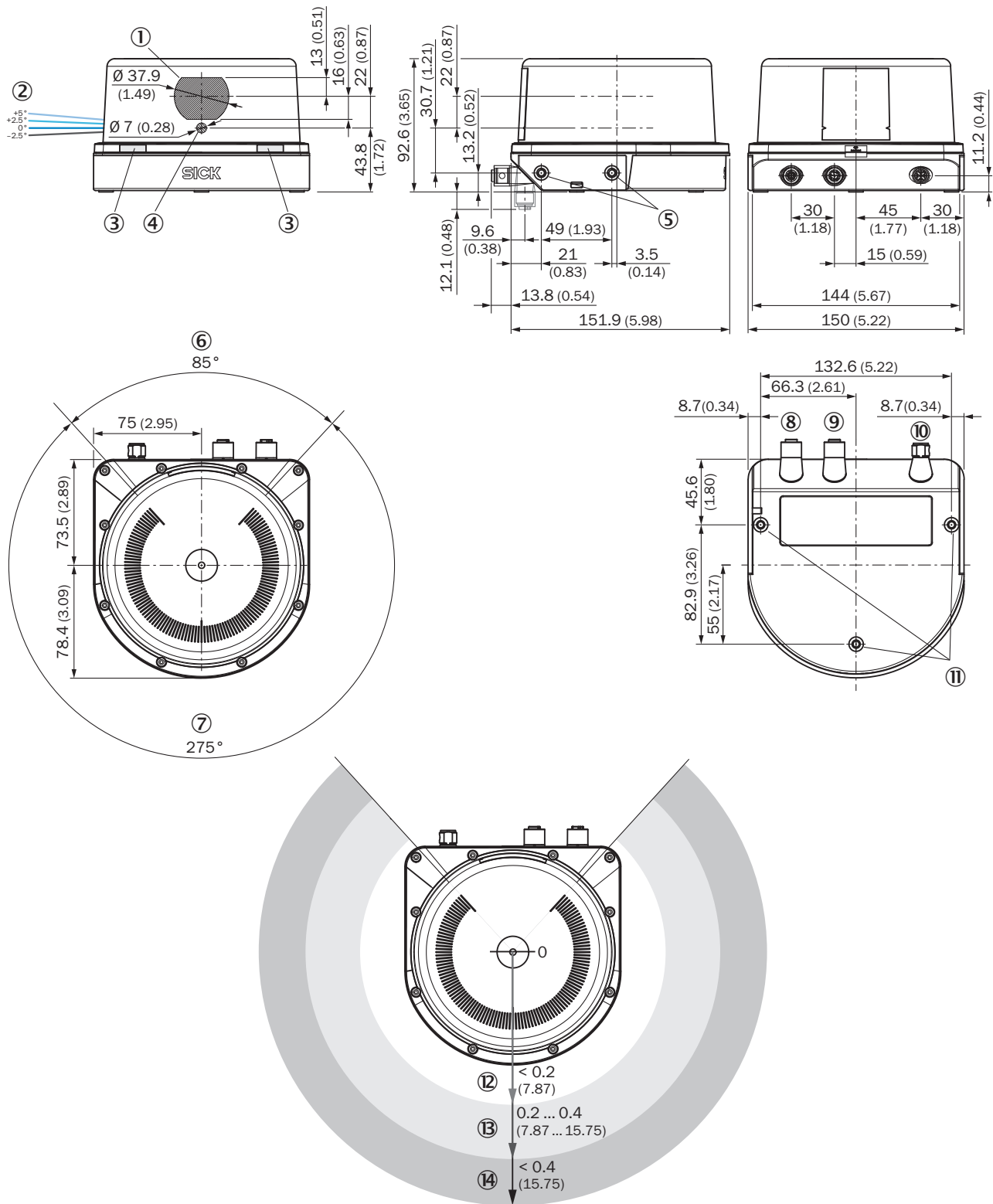

- ① Receiver
- ② Laser aperture angle, layers 1 to 4
- ③ Status LEDs
- ④ Sender
- ⑤ Mounting hole M5 x 7.5
- ⑥ Blind zone
- ⑦ Field of view
- ⑧ Ethernet connection
- ⑨ I/O connection
- ⑩ POWER connection
- ⑪ Mounting hole M5 x 7.5
- ⑫ Close range (no detection or measurement possible)
- ⑬ Detection zone

Working range diagram

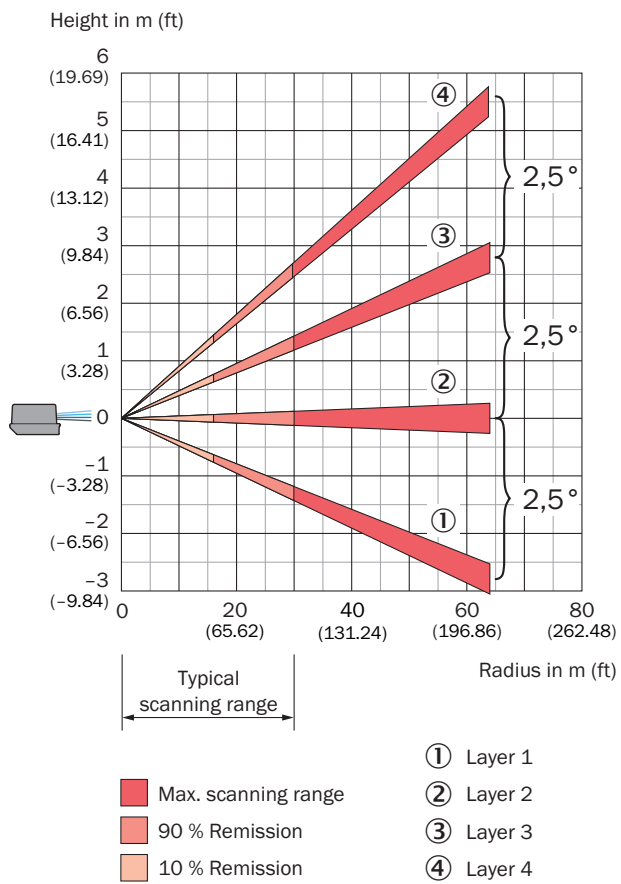

Scanning range in m

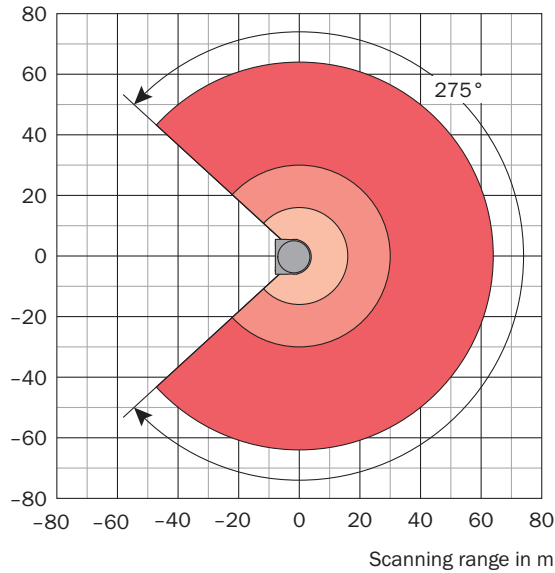

- Scanning range max. 64 m
- Scanning range for objects up to 90 % remission 30 m
- Scanning range for objects up to 10 % Remission 16 m

Connection type

I/O

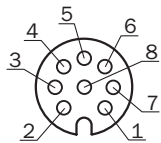

Connector M12, 8-pin, A-coded

- ① IN1/OUT1
- ② IN2/OUT2
- ③ IN3/OUT3
- ④ IN4/OUT4
- ⑤ IN5/OUT5
- ⑥ IN6/OUT6
- ⑦ GND INx/OUTx
- ⑧ IN7/OUT7

Ethernet

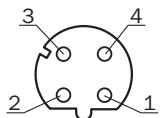

M12 female connector, 4-pin, D-coded

- ① TX+
- ② RX+
- ③ TX-
- ④ RX-



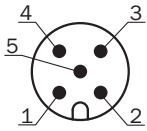

Power



Connector M12, 5-pin, A-coded

- ① VS 10...30 V
- ② Reserved
- ③ GND
- ④ IN8/OUT8
- ⑤ Reserved

Recommended accessories

	Brief description	Type	Part no.
Device protection (mechanical)			
	Optics cover for protecting the front screen from weather conditions, stainless steel, Aluminum, powder coated	Weather hood, 210°	2085939
Mounting brackets and plates			
	Standard mounting set for weather hood	Mounting bracket	2046025
Plug connectors and cables			
	Head A: male connector, M12, 8-pin, straight, A-coded Head B: Flying leads Cable: PUR, halogen-free, shielded, 5 m	STL-1208-G05MAC	6036155
	Head A: female connector, M12, 5-pin, straight, A-coded Head B: Flying leads Cable: Sensor/actuator cable, PUR, halogen-free, shielded, 5 m	YF2A25-050UB6XLEAX	2095733
	Head A: male connector, M12, 4-pin, straight, D-coded Head B: male connector, RJ45, 8-pin, straight Cable: Ethernet, twisted pair, PUR, halogen-free, shielded, 5 m	SSL-2J04-G05ME	6034415

SICK AT A GLANCE

SICK is one of the leading manufacturers of intelligent sensors and sensor solutions for industrial applications. A unique range of products and services creates the perfect basis for controlling processes securely and efficiently, protecting individuals from accidents and preventing damage to the environment.

We have extensive experience in a wide range of industries and understand their processes and requirements. With intelligent sensors, we can deliver exactly what our customers need. In application centers in Europe, Asia and North America, system solutions are tested and optimized in accordance with customer specifications. All this makes us a reliable supplier and development partner.

Comprehensive services complete our offering: SICK LifeTime Services provide support throughout the machine life cycle and ensure safety and productivity.

For us, that is “Sensor Intelligence.”



HEXAGON



AUTONOMOUSSTUFF

+1.309.291.0966 | AutonomousStuff.com | info@AutonomousStuff.com

SICK
Sensor Intelligence.