

Document MT0202P, Revision O, Nov 2019



Magnetic Calibration Manual

Revision	Date	By	Changes
A	June 29 2005	PSL	Initial release
...
K	27 February 2015	MHA	Corrected recommended settings for offline MFM Corrected start-up procedure for MTw
K1	10 May 2016	MHA	Typo (line color)
K2	7 Oct 2016	MHA	Added Scan Single Port feature Updated to new logo/icon Editorial changes
L	7 Aug 2017	MHA	Minor editorial changes
M	21 Nov 2018	SGI	Renamed document to "Magnetic Calibration Manual" Complete review of document to match with MTSS 2019 update. Included ICC/RepMo and AHS.
N	Sep 2019	SGI	Added remarks on using the low-level calibration result message. Added Position/Time setting requirement for WMM.
O	Nov 2019	AKO	Update to new brand identity

© 2005-2020, Xsens Technologies B.V. All rights reserved. Information in this document is subject to change without notice. Xsens, Xsens DOT, MVN, MotionGrid, MTi, MTi-G, MTx, MTw, Awinda and KiC are registered trademarks or trademarks of Xsens Technologies B.V. and/or its parent, subsidiaries and/or affiliates in The Netherlands, the USA and/or other countries. All other trademarks are the property of their respective owners.

Table of Contents

1 Introduction	6
2 Magnetic Distortion Theory	7
2.1 Background	7
2.2 Method	8
3 Using the Magnetic Field Mapper	10
3.1 Mounting of the MT	10
3.2 How to perform a calibration measurement	11
3.3 Performing the calibration measurement	12
3.4 Explanation of the Advanced Results	17
3.5 Most common error causes	19
1.1.1 3.5.1 Example reports of erroneous results	20
3.6 Example reports for various applications	23
4 Non-default calibration procedures	24
4.1 Use a previously recorded measurement	24
4.2 Off-line Magnetic Field Mapping	25
4.3 Magnetic Field Mapping SDK	29
4.4 In-Run Compass Calibration (ICC) and Representative Motion (RepMo)	30
4.4.1 Representative Motion (RepMo)	30
4.4.2 How to enable Representative Motion	30
4.4.3 In-Run Compass Calibration (ICC)	32
4.4.4 How to enable ICC	33
4.4.5 Storing the ICC/RepMo parameters	34
4.4.6 Conclusion	35
6. Support – BASE by Xsens	37

List of Tables

Table 1: Most common error causes	19
-----------------------------------	----

List of Figures

Figure 1: Flowchart for tackling magnetic distortions.....	8
Figure 2: The 3D magnetic field measurements (M_x, M_y, M_z) mapped onto the surface of a sphere with its centre at $(0, 0, 0)$	9
Figure 3: The norm of the magnetic field vector before (red) and after (blue) compensation using the Magnetic Field Mapper. The black dots represent the samples used by the MFM algorithm.....	9
Figure 4: Home screen of the Magnetic Field Mapper.....	12
Figure 5: Error message indicating no devices are found	13
Figure 6: Screen where you can select the MT to use	13
Figure 7: Screen where you select the logging directory	14
Figure 8: Screen showing the data capturing process	15
Figure 9: Screen indicating the overview results of the calibration	16
Figure 10: In the Advanced Results window, this figure shows the total movement of the MTi over all directions of an imaginary sphere. In the left image, the original magnetic field measurements are shown. The right image shows the magnetic field measurements after the MFM procedure. The rounder this sphere is, the better the MFM results are. ...	17
Figure 11: In the Advanced Results window, this figure shows whether the MFM was able to apply the new magnetic field model to all corrected magnetic field measurements of the file or measurement. When large spikes are visible, the data set used for the MFM may result in a magnetic field model of lesser quality.	17
Figure 12: In the Advanced Results window, this figure shows the residuals of the corrected magnetic field vector of the file or measurement with respect to the new magnetic field model. When measurements are visible outside the Gaussian distribution, the data set used for the MFM had errors, which may result in a magnetic field model of lesser quality. Ideally, the residual histogram follows the black line, indicating that the distribution of the residuals follows a Gaussian distribution.	18
Figure 13: In the Advanced Results window, this figure shows the norm of the magnetic field before and after Magnetic Field Mapping. It also shows which data points were used for the Magnetic Field Mapping, indicated by '+'. The more flat the blue line is (and the closer to 1.0), the better the calibration	18
Figure 14: This report shows even distribution of points on the sphere, has a normal distribution of residuals (fit within the Gaussian model), has small residuals in all directions and a norm after MFM of close to 1.	20
Figure 15: The points in the right sphere hover just above the surface of the model; the points do not fit to the model (and many points even fall outside the graph, see the red bars), residuals are large and the norm is not straight and/or close to 1.....	21
Figure 16: The points in the sphere do not form solid lines, almost all points are outside the graph in the Gaussian model plot, the residuals are very large in all directions and the norm after MFM is not 1.....	21
Figure 17: The spheres show hardly any points and are poorly distributed, resulting in large residuals. The norm after the MFM procedure is close to 1, but not constant.	22
Figure 19: Example report for a 2D Magnetic Field Mapping. The application is a wheeled robotic ground vehicle consisting of a large metal structure with batteries and motors nearby. During the calibration, the vehicle drove two full circles. Clearly, the calibration has been successful: the centre of the sphere has been transformed to 0 and the magnetic norm is nearly constant at 1.	23
Figure 20: Example report for a semi-3D Magnetic Field Mapping. The application is a drone. During the calibration, the drone tilted towards all possible directions. After	

calibration, the magnetic norm is nearly constant at 1 except for some noise – possibly caused by the drone’s on-board electronics and motors.....23

Figure 21: Home screen with "File Processing" selected.....24

Figure 22: Screen allowing to choose the file to be used for the MFM algorithm25

Figure 23: Home screen for the off-line procedure26

Figure 24: Screen to select the file for the off-line procedure27

Figure 25: Sending an MFM results message using the Device Data View in MT Manager. Indicated are the calibration result message pasted in the Message box, the BusID (0xFF) and the Checksum (0x06).28

Figure 26: Structure of the MFM SDK29

Figure 27: *Effects of Representative Motion on magnetic field measurements.*32

Figure 28: Data from the sensors (magnetometer and inertial sensors) are calibrated with the calibration parameters in the eMTS. The initial calibration parameters are a result of the factory calibration by Xsens. If ICC or the Representative Motion feature is on, filter states and compensation parameters are available in the RAM-memory. The magnetic field data (data output as shown in MT Manager) are not influenced by parameters in the RAM-memory.34

Figure 29: Once the command is given by the user to store the ICC calibration parameters, the MTi will write the parameters to the eMTS on the non-volatile memory. This way, the magnetometer sensor readings are calibrated with the ICC parameters before they are fed into the sensor fusion algorithm. Also, the magnetic field data will be outputted using the new calibration parameters.35

1 Introduction

An MTi/MTw motion tracker (MT) can be used to easily and accurately determine 3D orientation. For AHRS and GNSS/INS devices, such as the MTi-300 or MTi-G-710, this may include a North-referenced Yaw (Heading) output. For example, an MTi-300 under default East-North-Up (ENU) local reference frame configurations will output a Yaw of 0 degrees when its x-axis is pointing to the East. In order to do so, the MT acts as a compass by using its magnetometers to measure the Earth's magnetic field. However, when an MT is mounted onto an object that contains ferromagnetic materials, the measured (Earth) magnetic field is distorted (warped) and an error in estimated orientation may arise. Whether or not the MTi uses the magnetometers to estimate orientation depends on the selected filter profile. Please refer to the product User Manual for more details.

A disturbance of the magnetic field caused by mounting the MT onto a ferromagnetic object can be corrected for using specialized calibration tools that are described in this document. These calibration tools can be executed in a few minutes and yield a new set of digital calibration parameters (extended Motion Tracker Specification, or eMTS data) that can be written to the MT's non-volatile memory. Once written to memory, the orientation data estimated by the MT based on its magnetometers will be accurate despite being mounted onto a ferromagnetic object.

The calibration tools are suitable for both 3D applications, where the object is rotating through a substantial range of orientations (e.g. a handheld device), and 2D applications where the object moves more or less in one plane (e.g. a car or boat).

An accurate calibration of the magnetometers is performed by recording the output of the MT while rotating the object, with the MT mounted on it, in a space with a homogenous magnetic field and without other ferromagnetic materials nearby. Once the object is rotated over a sufficiently large amount of orientations, the calibration tools can then calculate new calibration parameters that can immediately be used by the MT.

If the object to which the MT is attached remains unchanged, then the calibration only needs to be performed once as long as the MT is mounted on the same location on the object. If properly carried out, the resulting accuracy will be comparable to the accuracy experienced with the MT without any ferromagnetic materials nearby.

Note: The Earth's magnetic field intensity and declination vary across the Earth and over time. Because of this, the MTi is equipped with an up-to-date [World Magnetic Model \(WMM\)](#), stored in its on-board memory. The location of the MTi can also be stored manually in its on-board memory, allowing the MTi to accurately reference its Yaw output with respect to the local magnetic field. Depending on the location on Earth, this may result in an offset correction of several degrees. The location of the MTi (in latitude/longitude/altitude format) and the current UTC time can be set in the Device Settings window of MT Manager, via the Xsens Device API or by using low-level communication. The default location in memory is the test and calibration environment in Enschede, the Netherlands. GNSS-enabled MTi devices will automatically retrieve the location and UTC time from the GNSS receiver.

2 Magnetic Distortion Theory

2.1 Background

The direction of the measured Earth magnetic field is used as a (3D) compass to determine the direction of the North (heading or yaw). This direction is used as an absolute reference in the MT's orientation estimation algorithms.

A locally disturbed (warped) magnetic field causes an error in orientation that can be quite substantial. Ferromagnetic materials, permanent magnets or very strong currents (several amperes) alter the local Earth magnetic field. Whether an object is ferromagnetic should preferably be checked by using the MT's magnetometers. It can also be checked with a small magnet, **but be careful, you can easily magnetize** some ferromagnetic materials, causing even larger errors. If you find that some object is magnetized (hard iron effect, this is often the case with for example stainless steels that are normally not magnetic), it may be possible to "degauss"¹ the object.

NOTE: Never expose the MT to strong magnetic fields. The MT contains the absolute possible minimum of ferromagnetic materials ("hard" and "soft" magnetic materials). Nonetheless, some minor components can be magnetized permanently by exposure to strong magnetic fields. This will not damage the unit but will render the calibration of the magnetometers useless, typically observed as a (large) deviation in heading. For mild magnetization, it may be possible to compensate for the magnetization of the device by a re-calibration (magnetic field mapping). Taking care not to expose the MT to strong magnetic fields, such as close proximity of permanent magnets, speakers, electromotors, etc. will prevent magnetization.

In practice, the distance to the object and the amount of ferromagnetic material determines the magnitude of disturbance.

Distortions of the Earth magnetic field can be divided into two kinds of effects:

1. **Temporal or Spatial disturbances.** These disturbances can be caused by objects in the environment of the motion tracker, like file cabinets or vehicles that move **independently** with respect to the MT. This type of disturbance is **non-deterministic**, and cannot be fully compensated for. However, the amount of *error* caused by the disturbance can be *reduced* by optimally using the available sensor information and valid assumptions about the application. This is the task of the Xsens Kalman Filter (XKF) or Xsens Estimation Engine (XEE) running inside the on-board processor of the MT.
2. **Static disturbances.** These disturbances are often caused by mounting the MT to an object of which the motion is to be recorded (the MT moves with the object). The error in magnetic field is **constant**, and can therefore be predicted (i.e., it is **deterministic**) and taken into account during motion tracking. By mapping the disturbance (warping) of the magnetic field the errors caused by this type of

¹ Degaussing is a procedure to apply strong alternating magnetic fields with decreasing magnitude in random direction to an object that has been magnetized. The effect of the strong alternating fields is to remove any magnetized (aligned) domains in the object. If you degauss, please make sure the MT is not mounted on the object during the procedure!

disturbance can in theory be reduced to zero. The calculations and methodology required to achieve this are supplied by this Magnetic Calibration Manual. This type of correction is also commonly known as compensation for hard and soft iron effects.

Disturbances of the first type cannot be calibrated for. Instead, you may want to consider the use of Active Heading Stabilization (AHS) as an alternative. Refer to the following article for more information: <https://base.xsens.com/hc/en-us/articles/211809465-Active-Heading-Stabilization-AHS->

Disturbances of the second type can be calibrated for. This document describes three tools that can be used to achieve this:

1. **Magnetic Field Mapper (MFM)**: This is the most powerful and therefore preferred calibration procedure.
2. **Representative Motion (RepMo)**: An embedded solution that can be used to achieve a fast and effective magnetic calibration in situations where a connection with a host PC is not possible.
3. **In-Run Compass Calibration (ICC)**: An embedded solution that can perform a continuous on-board magnetic calibration.

Figure 1 presents a flow chart that can help you decide which tool to use.

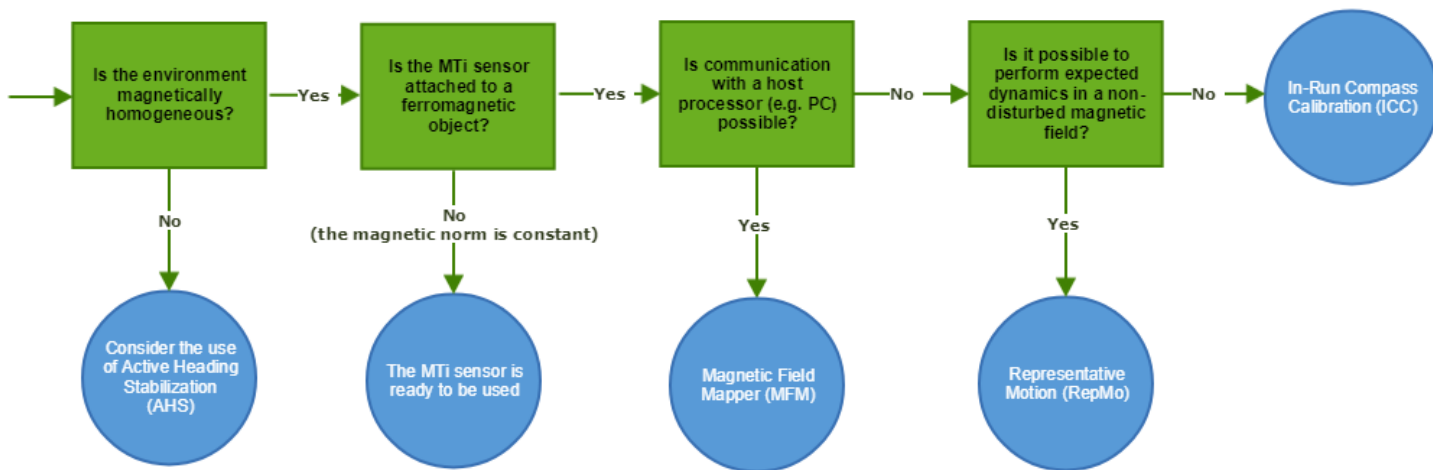

Figure 1: Flowchart for tackling magnetic distortions.

2.2 Method

In a non-disturbed magnetic field, we define the 3D measured magnetic field vector $\vec{M} = (M_x, M_y, M_z)$ to have a magnitude (magnetic norm) $|\vec{M}|$ equal to **1** and therefore all measured points would ideally lay on the circumference of a 3-dimensional sphere with its centre at zero, see Figure 2. In the case of a disturbed magnetic field, this sphere is

both shifted and warped. The calibration procedures described in this document aim to derive a function that maps the measured magnetic field vector to a sphere, and the magnetic norm to 1, see Figure 3. This function is then used to create new magnetometer calibration parameters, which are stored in non-volatile memory in your MT.

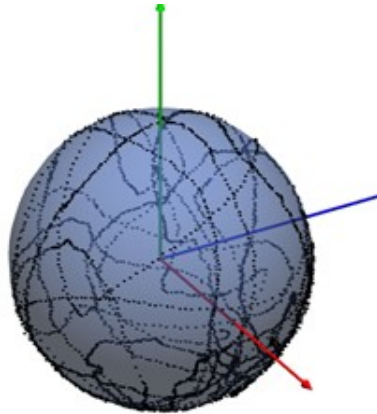

Figure 2: The 3D magnetic field measurements (M_x, M_y, M_z) mapped onto the surface of a sphere with its centre at $(0, 0, 0)$.

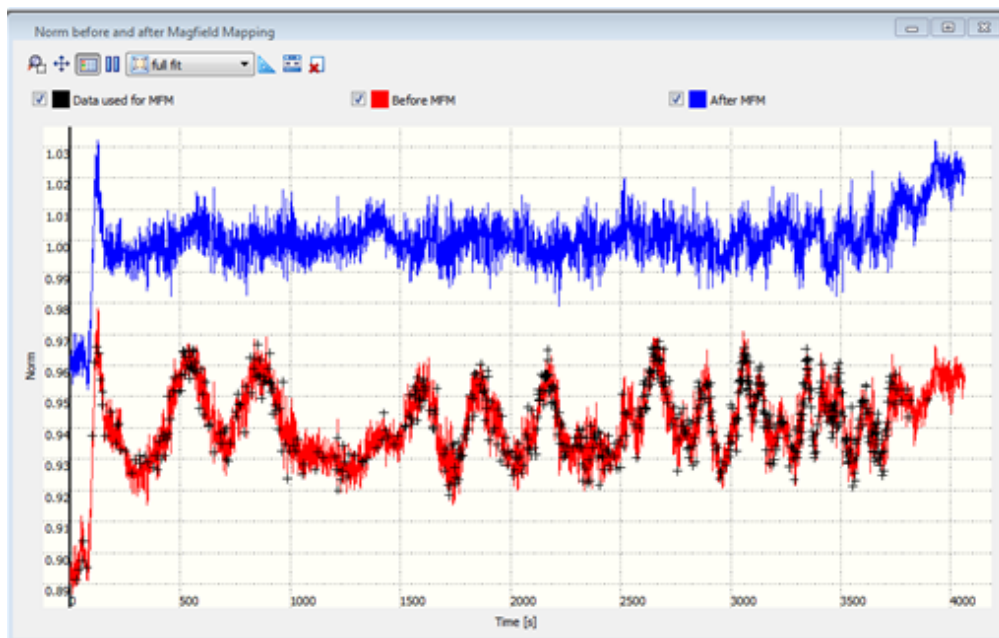

Figure 3: The norm of the magnetic field vector before (red) and after (blue) compensation using the Magnetic Field Mapper. The black dots represent the samples used by the MFM algorithm.

3 Using the Magnetic Field Mapper

The Magnetic Field Mapper can be used by executing the following steps:

1. Mounting of the MT
2. Recording of calibration measurement using the Magnetic Field Mapper software or other logging software
3. Processing of measurement data by the Magnetic Field Mapper software
4. Writing the results to Motion Tracker using the Magnetic Field Mapper software or by transmitting a specialized message to the Motion Tracker

In the case that, after mounting the MT, it cannot be directly connected to a PC that runs the Magnetic Field Mapper software it is possible to perform magnetic field mapping off-line. This is described in section 4.2. The standard procedure is described in the following sections.

3.1 Mounting of the MT

The MT is attached to the object for which the magnetic field mapping procedure is carried out. Make sure that wherever the MT is placed, it cannot move with respect to the object. There are **no** specific requirements in terms of mounting orientation of the MT with respect to the object.

Remarks:

- If possible, avoid mounting the MT close to sharp edges of ferromagnetic material as these are 'focus points' of a magnetic distortion; the distortion will be most severe at these locations.
- Every time the sensor is temporarily removed from the object, it is advised to repeat the calibration procedure.
- If the geometry of the object is significantly altered, e.g. the geometry is changed or components are added or removed, it is advised to repeat the calibration procedure.
- The calibration procedure is more accurate for smaller disturbances. If possible, try to position the sensor one to a few centimetres/inches away from ferromagnetic materials. The Magnetic Field Mapper will automatically warn you if the magnetometers in the MT become saturated.

3.2 How to perform a calibration measurement

During a 3D calibration measurement, the object to which the sensor is attached has to be rotated through as **many different orientations as possible**, it may help to think about 'scanning' the surface of a sphere with the MT x-axis. It is important to cover as many orientations as possible, at least that many that will cover the envelope of motion of your application.

In case of a 2D calibration measurement, the object has to be rotated through at least a full 360° circle. It is recommended to do this with constant and low (<15 km/h) speed.

Note: The MFM algorithm will always try to find a solution, even if there is only a partial capture. This means that when the MFM has been performed in the orientations of the intended application only, the heading will be accurate in those orientations, but possibly not outside that captured envelope.

The Magnetic Field Mapper will tell you if the measurement was OK.

Calibration remarks:

- It is required to rotate the MT in as many different orientations as possible. To reach all points, as can be seen in Figure 10, as a rule of thumb a calibration trial of around three minutes should suffice, provided that the object is rotated over a sufficiently large angle and held sufficiently still. If one of these requirements is not met, a longer calibration trial may prove to be useful.
- For a 2D calibration measurement, it is recommended that the object moves through a full 360° circle.
- It is extremely important to perform the calibration in a magnetic homogeneous field. Try to conduct the measurement *at least* 3 meters from large ferromagnetic objects such as radiators and iron desks.
- During the calibration trial, Xsens orientation estimates are used for inclination measurement. This means that the inclination accuracy will be less when the sensor is accelerated. Especially centripetal accelerations that occur e.g. during swinging result in a large inclination error.

3.3 Performing the calibration measurement

If the MT can be directly connected to a PC, the Magnetic Field Mapper software can be used to record the calibration measurement data. If this is not the case, refer to Section 4.2 to setup the off-line procedure.

1. To start the recording of the calibration measurement, start the Magnetic Field Mapper from the Xsens folder in Program Files or the Start Menu.
2. Choose the 'Write results to Motion Tracker non-volatile memory' option if the Motion Tracker is directly connected to the PC running the Magnetic Field Mapper software. For MTw, first establish a wireless connection using the MT Manager (100 Hz) and then close MT Manager to allow the MTw to communicate via Magnetic Field Mapper.

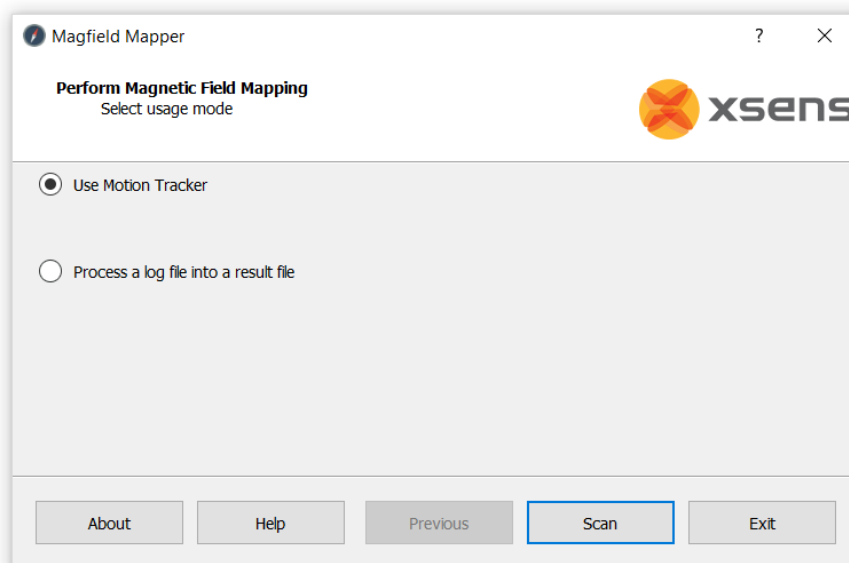

Figure 4: Home screen of the Magnetic Field Mapper

3. Press "Scan" to scan for the connected MT. If the MT is not found, the following dialog is shown.

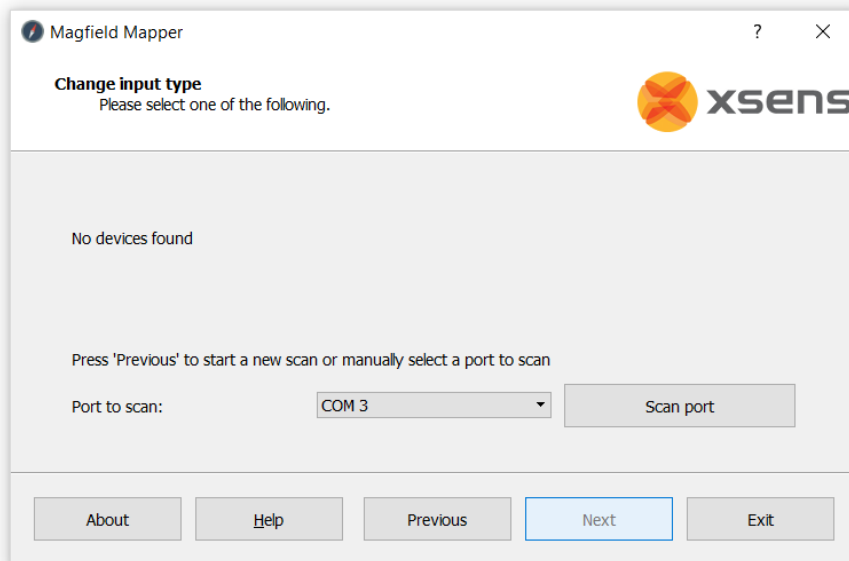

Figure 5: Error message indicating no devices are found

4. Scan the required port and click Next. If an MT is found, you should see the following dialog.

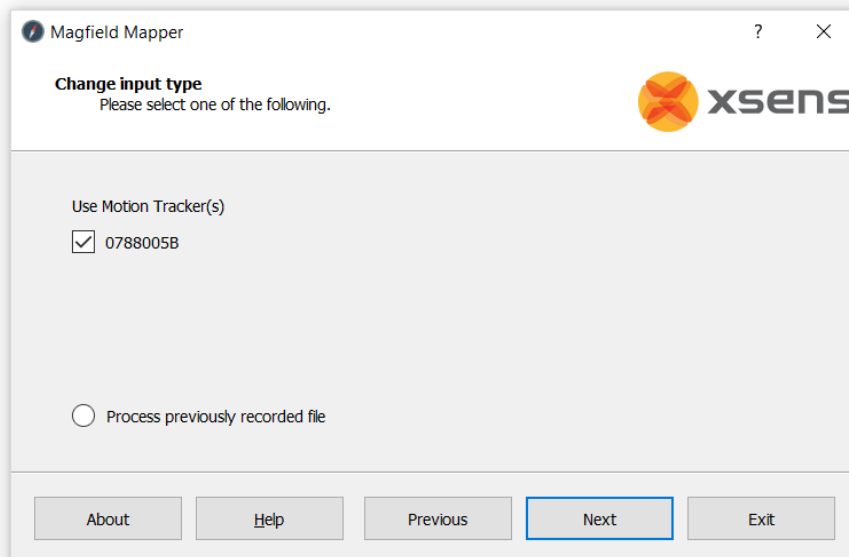

Figure 6: Screen where you can select the MT to use

5. Click "Next" and select the location where the software stores the log file of the calibration measurement.

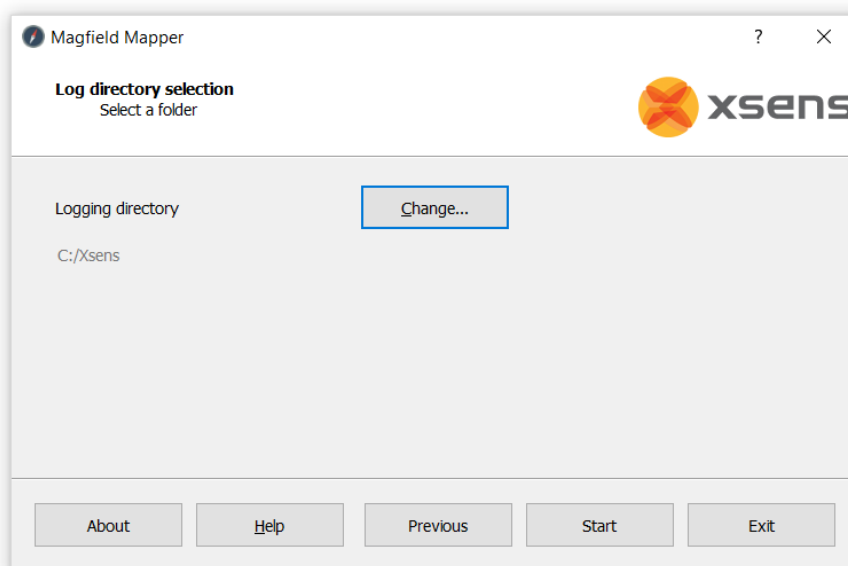

Figure 7: Screen where you select the logging directory

6. The software is now ready to start the calibration measurement. Read section 3.2 for more information about how to perform the measurement. Click "Start" to begin the measurement. A window will open, visualizing the magnetic field data points, as they are being collected. Make sure to cover the surface of the globe as much as possible by rotating the MT in all possible directions.

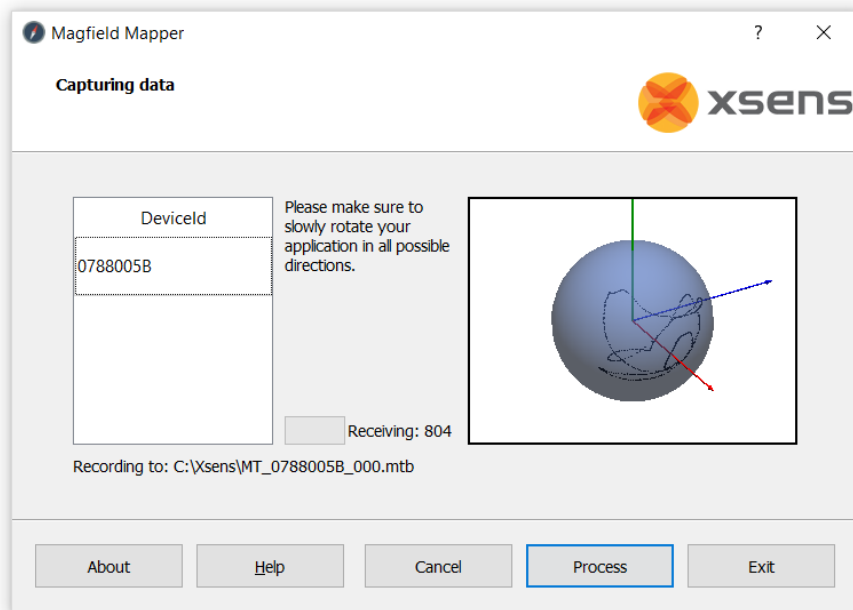

Figure 8: Screen showing the data capturing process

7. When the sequence of rotations is completed press "Stop" to end the measurement and to start the analysis of the data. A window will pop up, visualizing the calibration results.

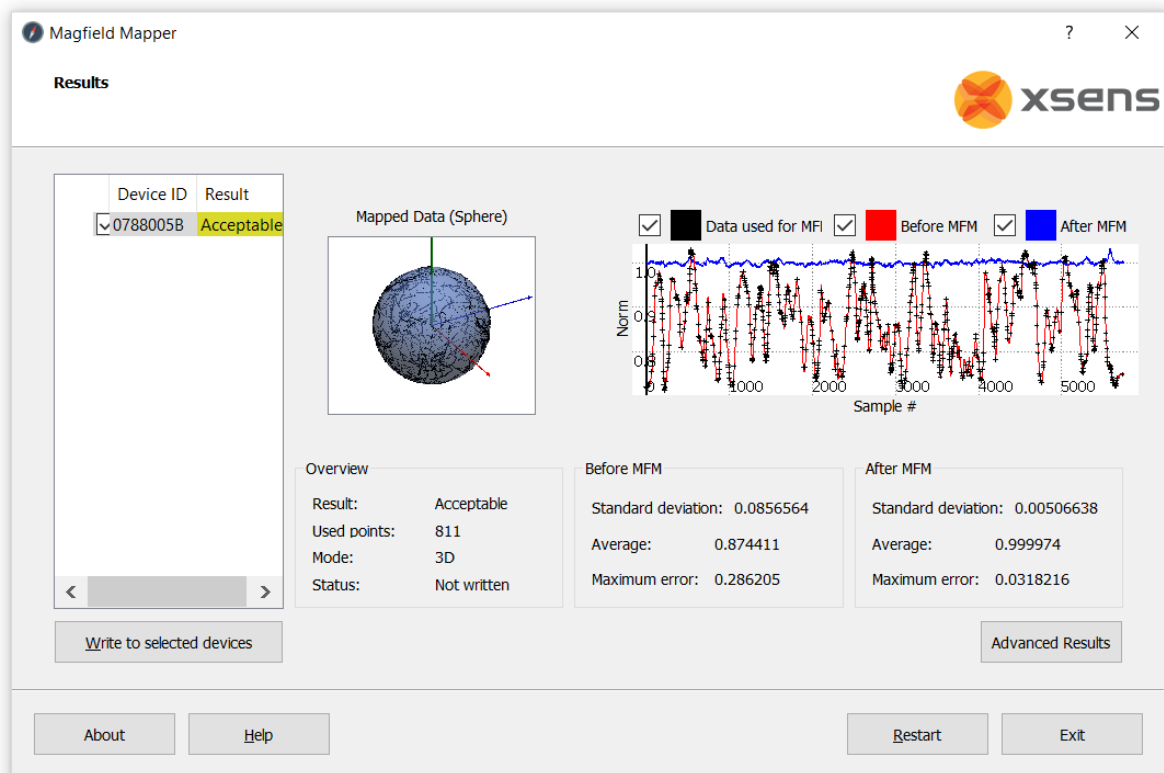

Figure 9: Screen indicating the overview results of the calibration

- The *Overview* presents general information regarding the calibration. The "Result" value indicates the quality of the calibration, and can be one of four values: *Good*, *Acceptable*, *Bad* or *Fail*. The amount of "Used points" indicates how many magnetic field data samples were used by the Magnetic Field Mapper software. "Mode" indicates whether a calibration has been performed in 3D or 2D. "Status" indicates whether the calibration parameters have been written to device memory.

The *Before MFM* and *After MFM* sections state the most important specifications related to the calibration:

- Standard deviation of the norm; this value should be as low as possible;
- Average of the norm: this value should be as close to 1 as possible;
- Maximum error w.r.t. a norm of 1: this value should be as low as possible.

By clicking *Advanced Results*, the quality of the calibration can be reviewed in more detail, see Section 3.4.

Upon review of the results, they can be stored in MT memory by clicking "Write to selected devices". This is necessary for the MT to be able to use the updated calibration parameters in the future.

3.4 Explanation of the Advanced Results

The Advanced Results window of the Magnetic Field Mapper generates several reports which are discussed below.

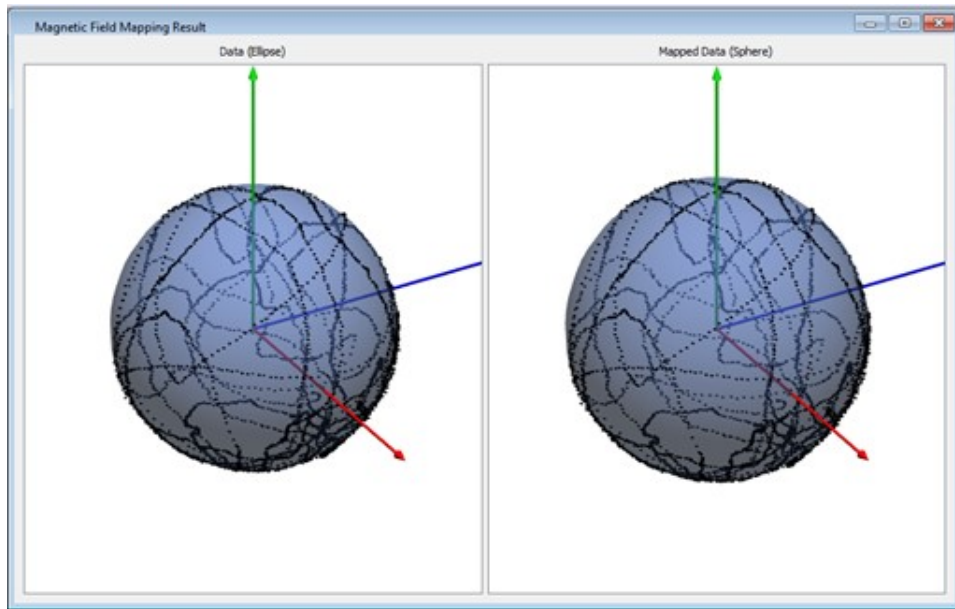

Figure 10: In the Advanced Results window, this figure shows the total movement of the MTi over all directions of an imaginary sphere. In the left image, the original magnetic field measurements are shown. The right image shows the magnetic field measurements after the MFM procedure. The rounder this sphere is, the better the MFM results are.

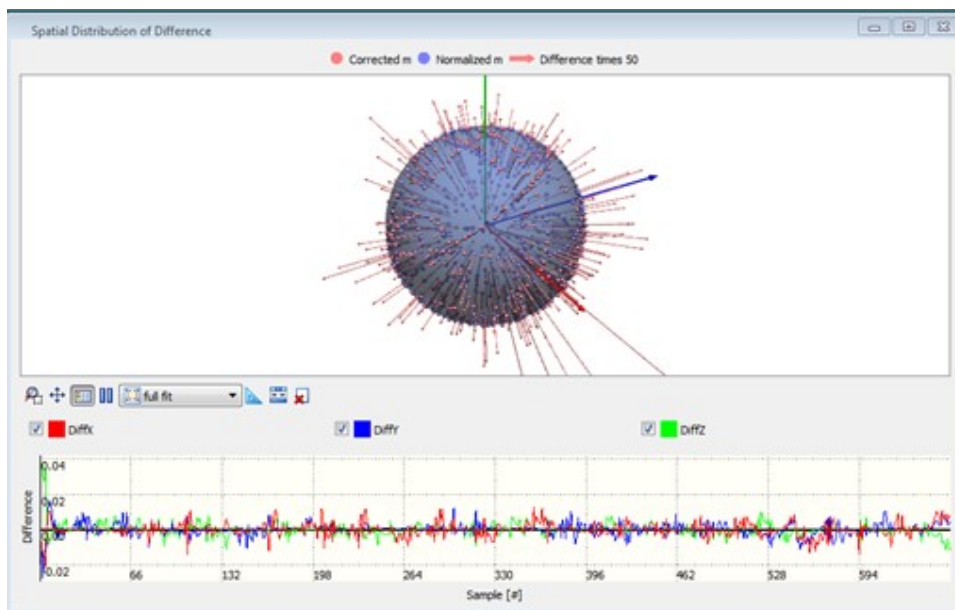

Figure 11: In the Advanced Results window, this figure shows whether the MFM was able to apply the new magnetic field model to all corrected magnetic field measurements of the file or measurement. When large spikes are visible, the data set used for the MFM may result in a magnetic field model of lesser quality.

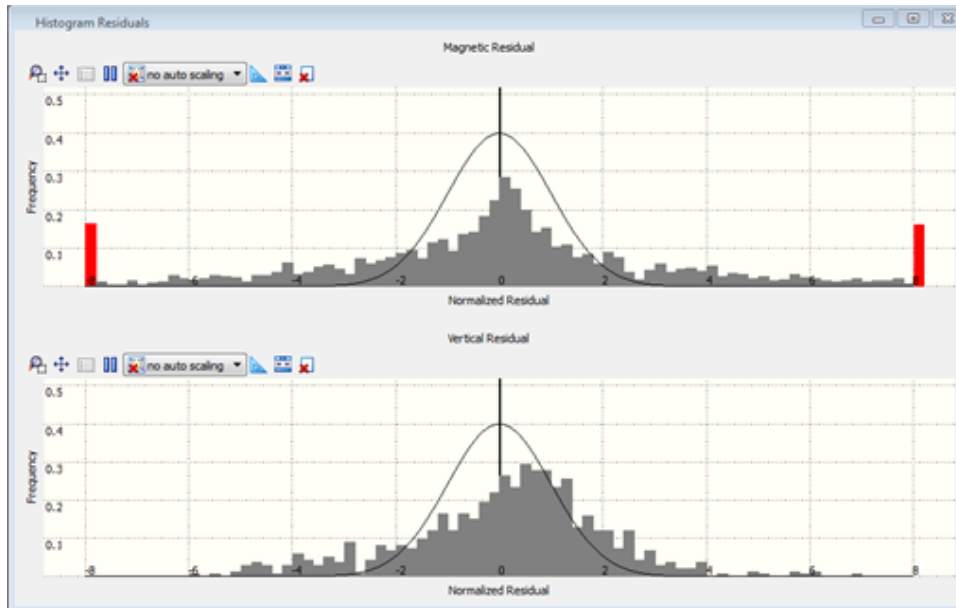

Figure 12: In the Advanced Results window, this figure shows the residuals of the corrected magnetic field vector of the file or measurement with respect to the new magnetic field model. When measurements are visible outside the Gaussian distribution, the data set used for the MFM had errors, which may result in a magnetic field model of lesser quality. Ideally, the residual histogram follows the black line, indicating that the distribution of the residuals follows a Gaussian distribution.

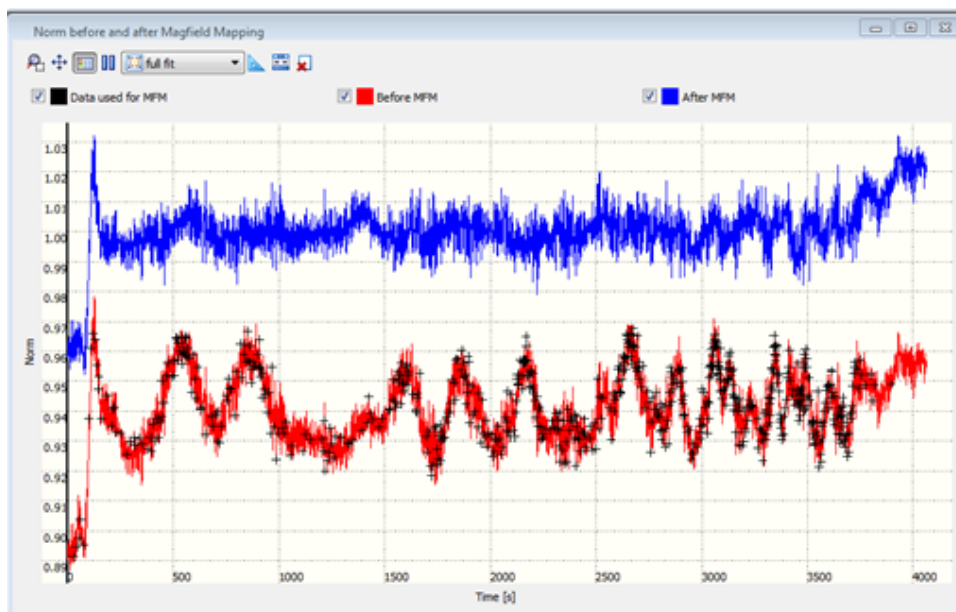

Figure 13: In the Advanced Results window, this figure shows the norm of the magnetic field before and after Magnetic Field Mapping. It also shows which data points were used for the Magnetic Field Mapping, indicated by '+'. The more flat the blue line is (and the closer to 1.0), the better the calibration

3.5 Most common error causes

If the calibration procedure is not giving the desired results, it may be caused by one of the following error sources:

Table 1: Most common error causes

Cause	Explanation
Non homogeneous magnetic field in measurement volume	<p>The effect of a non-homogeneous measurement field shows in large residuals even though you follow procedure.</p> <p>To remedy this problem, try to perform the calibration measurement in a different place or remove nearby metal objects.</p>
Saturation	<p>The disturbance of the magnetic field can be so extreme that the magnetometers are saturated. In this case, a warning will be given.</p> <p>Reposition the MT on the object, away from the ferromagnetic material and not close to sharp edges, to remedy this problem.</p>
Large accelerations	<p>If the object is accelerated too much during calibration this will cause an error. If large accelerations cannot be avoided contact the Xsens support team at http://www.xsens.com/support.</p>
Limited rotation	<p>The calibration procedure is designed to process measurements in which the MT is rotated through a large amount of possible orientations even though measurements with a limited range of motion will most likely give good results as well.</p>
Extreme disturbance of magnetic field	<p>It can be that the disturbance of the magnetic field is so extreme that the program cannot find any function to correct the disturbance. This could occur more easily when one of the other error causes play a significant role.</p> <p>The result of such an error will become apparent in very high residuals or an error message.</p>

1.1.1 3.5.1 Example reports of erroneous results

The Magnetic Field Mapper algorithm will always try to produce a result. Only when the internal results are unrealistic, the Magnetic Field Mapper will not output the results.

This chapter provides several example reports in order to be able to recognize disturbances.

Correct Magnetic Field Mapping

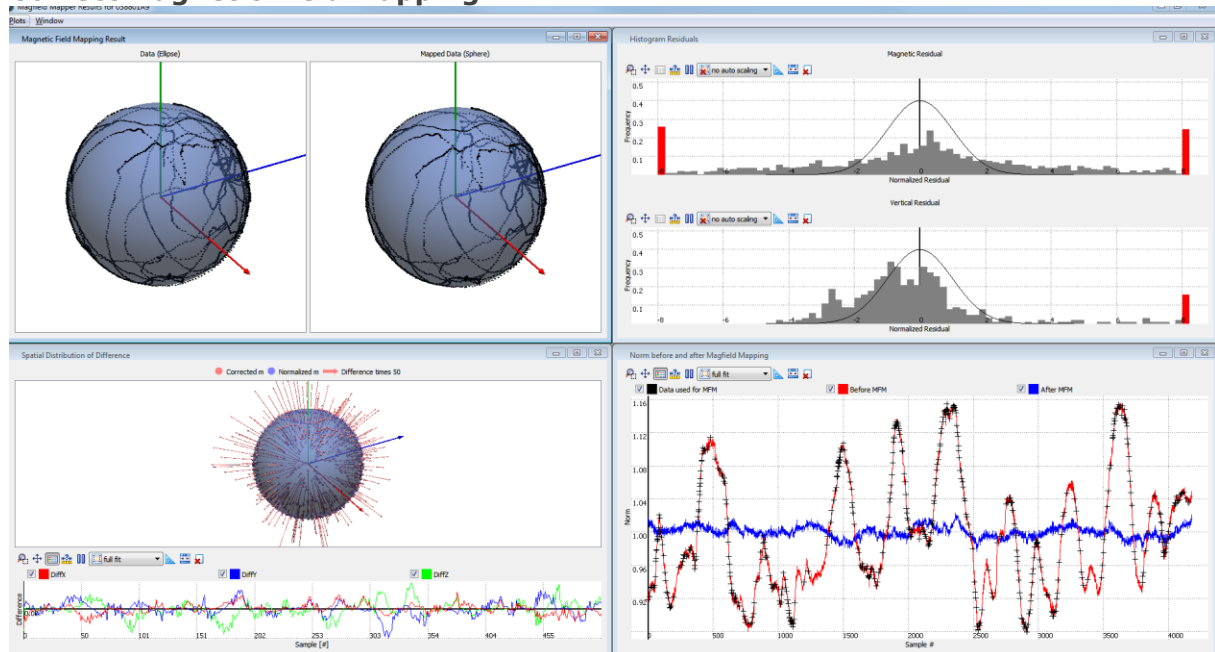

Figure 14: This report shows even distribution of points on the sphere, has a normal distribution of residuals (fit within the Gaussian model), has small residuals in all directions and a norm after MFM of close to 1.

Too much magnetic disturbance

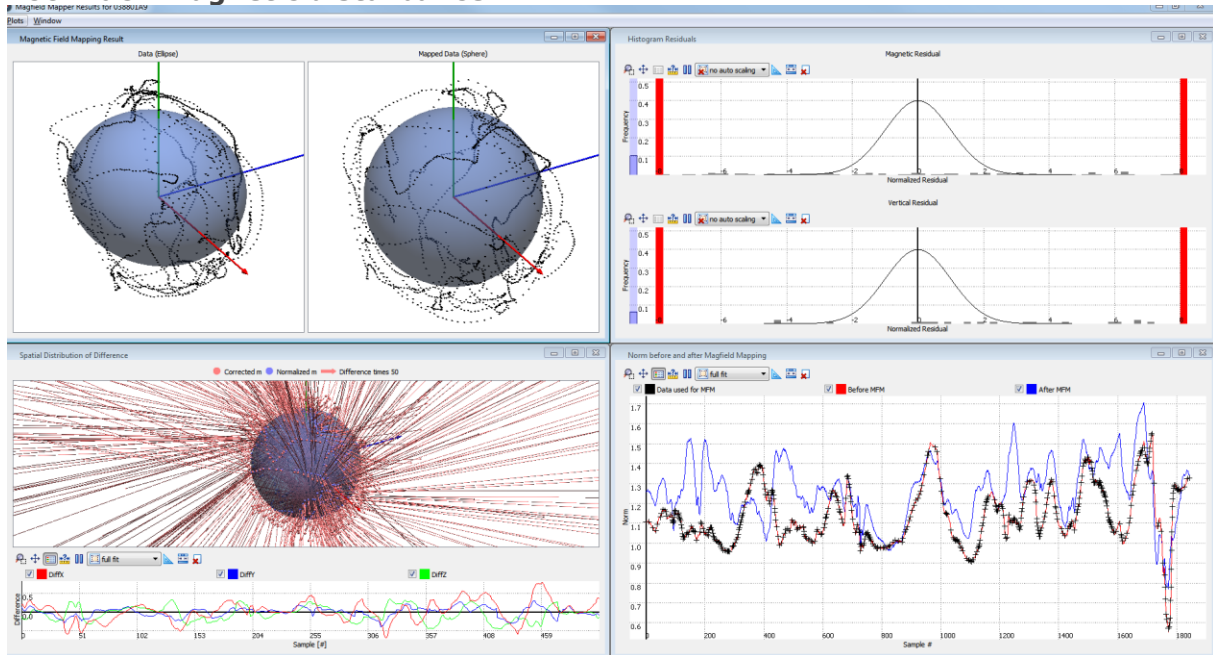

Figure 15: The points in the right sphere hover just above the surface of the model; the points do not fit to the model (and many points even fall outside the graph, see the red bars), residuals are large and the norm is not straight and/or close to 1.

Large accelerations

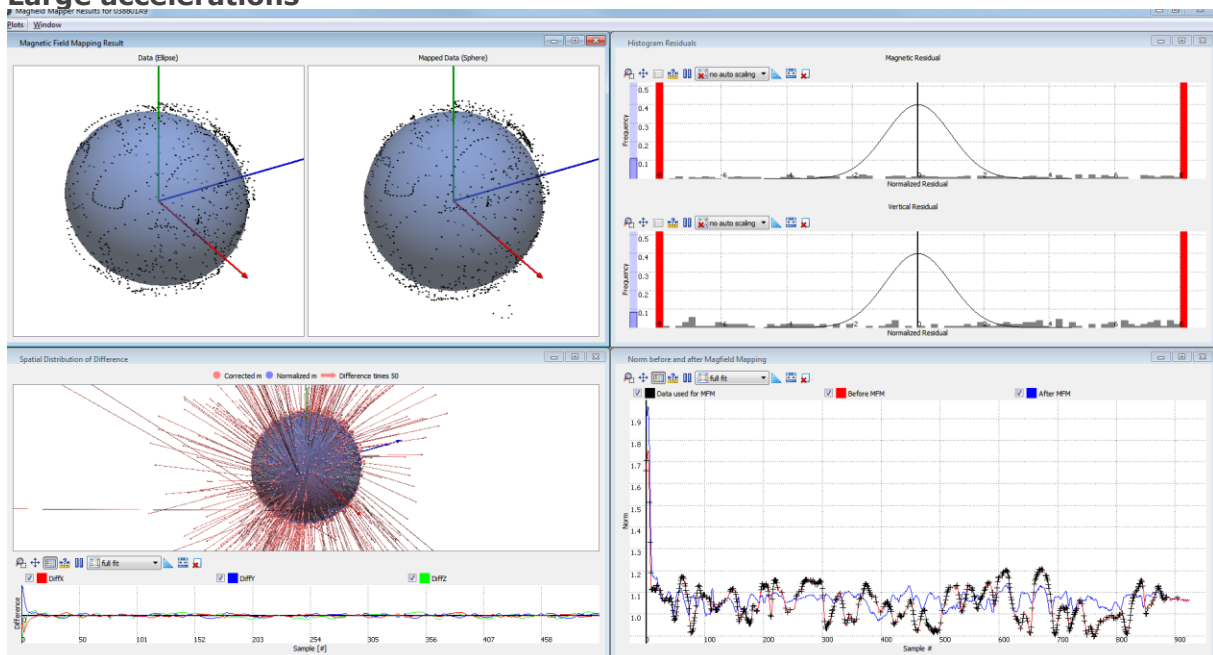

Figure 16: The points in the sphere do not form solid lines, almost all points are outside the graph in the Gaussian model plot, the residuals are very large in all directions and the norm after MFM is not 1.

Not enough points

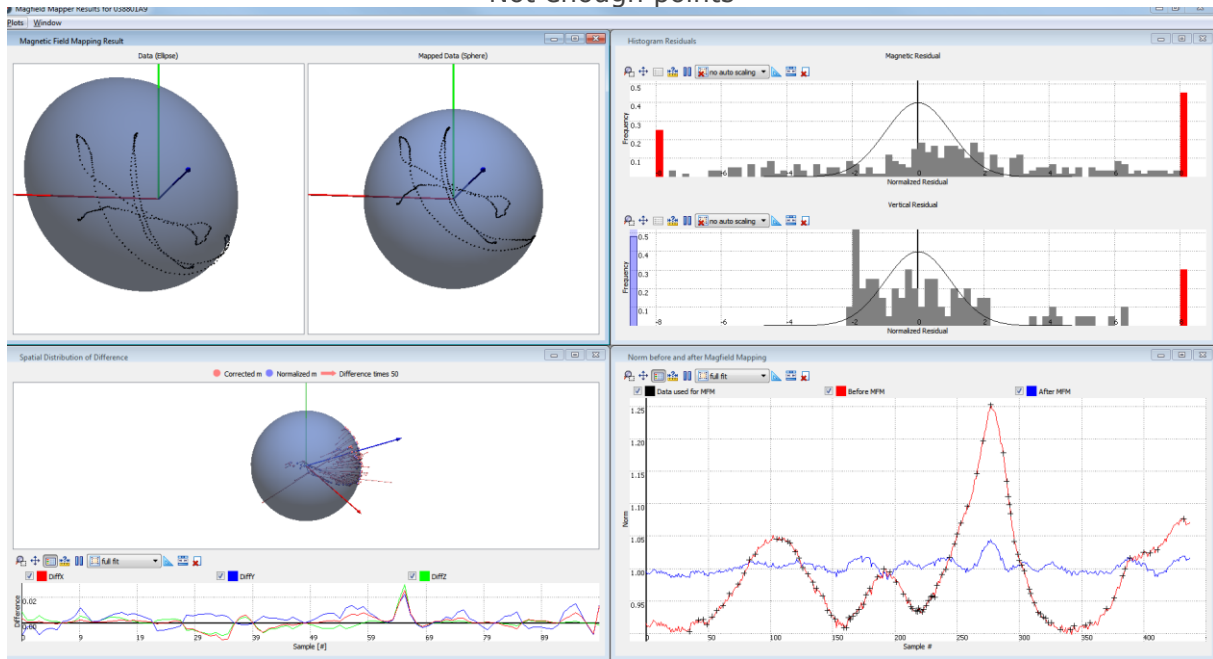

Figure 17: The spheres show hardly any points and are poorly distributed, resulting in large residuals. The norm after the MFM procedure is close to 1, but not constant.

3.6 Example reports for various applications

Depending on the application in which the MT is used and the amount of dynamics, calibration reports may differ in appearance. This section provides several (successful) example reports for various use cases.

2D calibration: Wheeled robotic ground vehicle

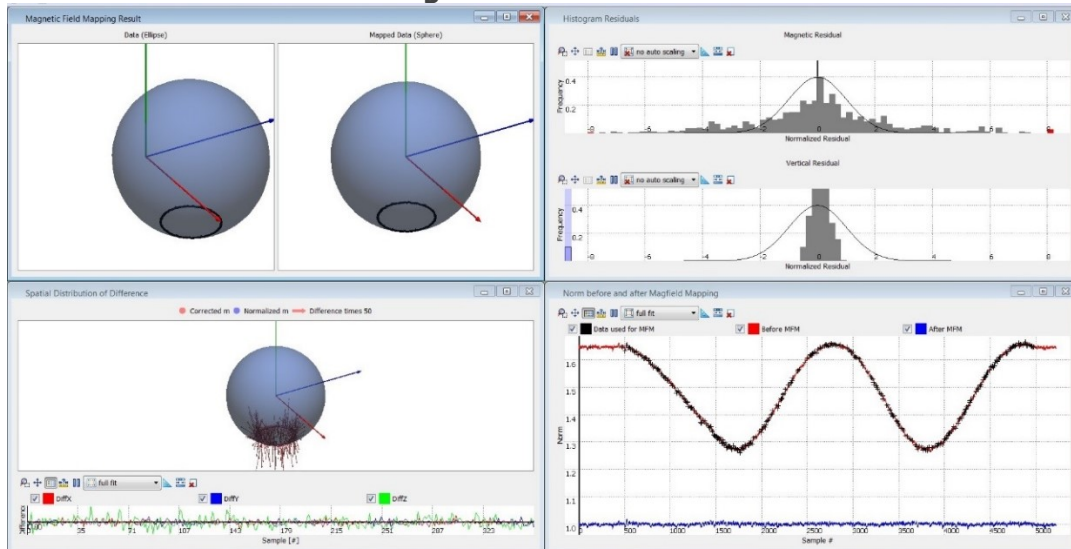

Figure 18: Example report for a 2D Magnetic Field Mapping. The application is a wheeled robotic ground vehicle consisting of a large metal structure with batteries and motors nearby. During the calibration, the vehicle drove two full circles. Clearly, the calibration has been successful: the centre of the sphere has been transformed to 0 and the magnetic norm is nearly constant at 1.

Semi-3D calibration: Drone

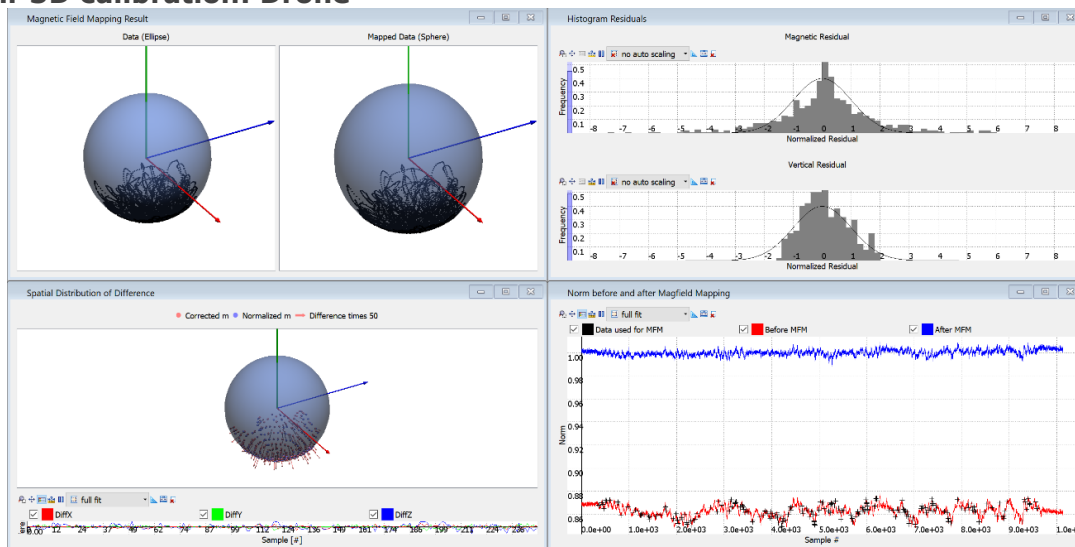

Figure 19: Example report for a semi-3D Magnetic Field Mapping. The application is a drone. During the calibration, the drone tilted towards all possible directions. After calibration, the magnetic norm is nearly constant at 1 except for some noise – possibly caused by the drone’s on-board electronics and motors.

4 Non-default calibration procedures

This section describes non-default procedures to calibrate the MT for magnetic disturbances.

4.1 Use a previously recorded measurement

For every calibration, the Magnetic Field Mapper software processes a log file which contains the sensor data logged during measurement. The location of these log files is set prior to the measurement in one of the Magnetic Field Mapper dialogs (by default the %temp% folder). These log files have the following name:

MT_XXXXXXXX_SSS.mtb

Where XXXXXXXX is the Serial Number of the MT and SSS is the session number of the Magnetic Field Mapping procedure.

If it is necessary to use the results of a previously recorded measurement, the Magnetic Field Mapper can process a previously recorded log file. Use the following procedure to accomplish this:

1. Start the Magnetic Field Mapper software and select 'Use Motion Tracker'.
2. Select 'Process Previously recorded file'

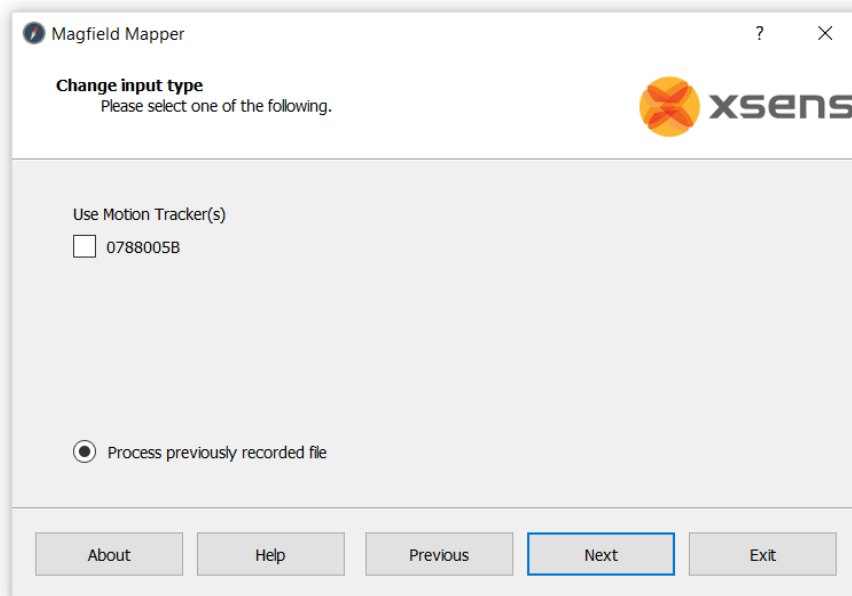

Figure 20: Home screen with "File Processing" selected

3. Load a previously recorded file from a previous MFM procedure. By default, you can find these in the temp folder: type %temp% in the Windows Explorer bar.

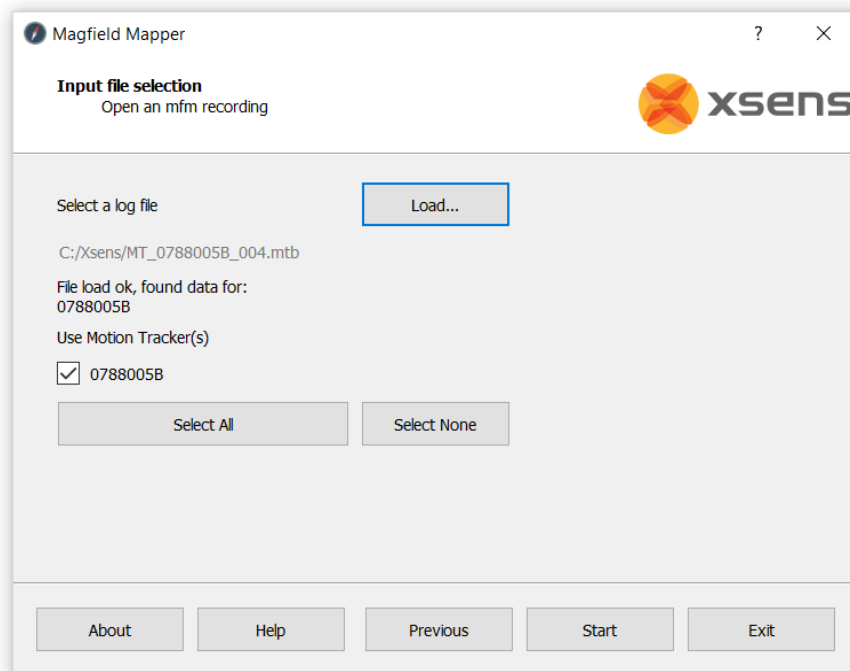

Figure 21: Screen allowing to choose the file to be used for the MFM algorithm

4. The rest of the procedure is identical to the default procedure, see Section 3.

4.2 Off-line Magnetic Field Mapping

If the Motion Tracker cannot be directly connected to a PC for an on-line measurement, it is possible to 'manually' generate a log file with measurement data. This log file can be processed off-line by the Magnetic Field Mapper software. As the calibration results cannot be directly stored in the MT the Magnetic Field Mapper generates a binary result file. This file contains a custom MT message that updates the calibration data of the MT if the message is transmitted to the MT.

Generate a log file

To generate a valid Magnetic Field Mapper log file follow these instructions.

1. Configure the MT for XDA processing (see below). To do so in MT Manager, navigate to Device Settings → Output Configuration and select "XDA Processing" from the preset dropdown menu. Click "Write to MT" to save the configuration.
2. While recording the incoming data into a file perform the measurement. See Section 3.2 for guidelines on how to perform a proper calibration trial.

Process the log file

After generating the log file the Magnetic Field Mapper software can process this and generate a result file. Follow these steps to generate a MFM result file:

1. Copy the log file to a system on which the Magnetic Field Mapper is installed (or check if it available using the network).
2. Start the Magnetic Field Mapper software
3. Select 'Process a log file into a result file' and press 'Next'

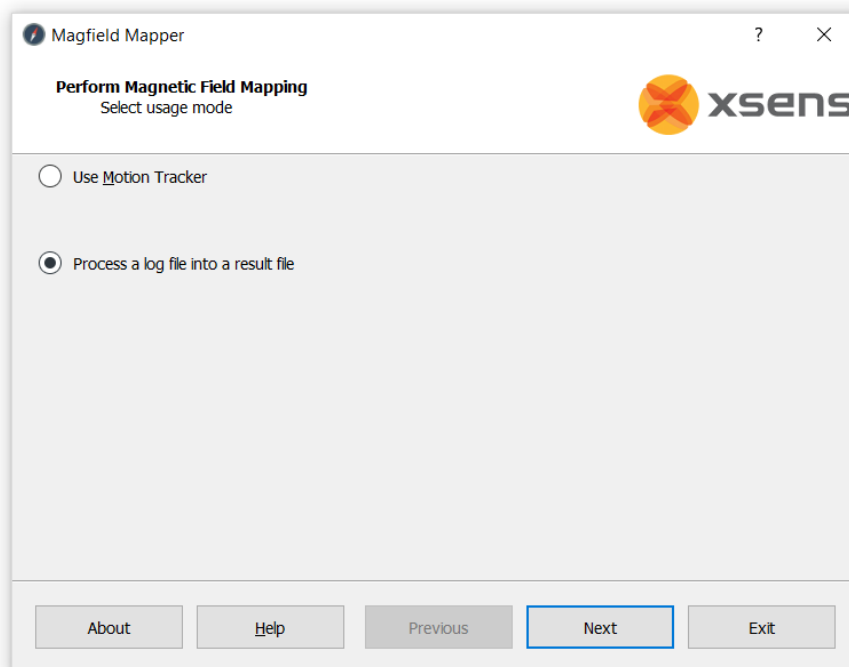

Figure 22: Home screen for the off-line procedure

4. Click 'Load' to browse for the log file.

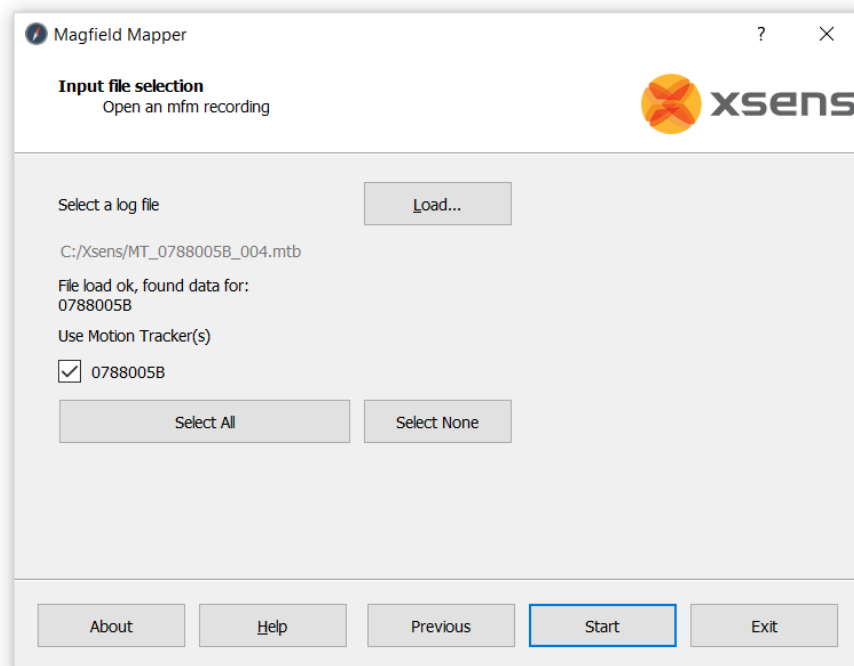

Figure 23: Screen to select the file for the off-line procedure

5. Click Start, check the results and if you are satisfied click 'Write file for selected devices' to generate the MFM results file. This file is stored in the same folder as the input log file.
 The filename of the MFM results file is:
 X_result_DID.bin
 ...where X is the original file name and DID the Device ID.

Write calibration results to MT

The MFM results file contains a single Xbus message that contains the calibration results. If this message is sent to the MT, it will update the non-volatile memory which holds the calibration values. Follow the next instructions to update the calibration parameters:

1. Copy the MFM results file to the system that has a direct connection to the MT.
2. Ensure that the MT is powered on.
3. Make sure that the MT is in **Config** mode.
4. Write the binary data message in the MFM results file to the sensor as a single XBus message, using binary communication. In MT Manager, you can test this procedure by opening the Device Data View and pasting the MFM results message into the message field.

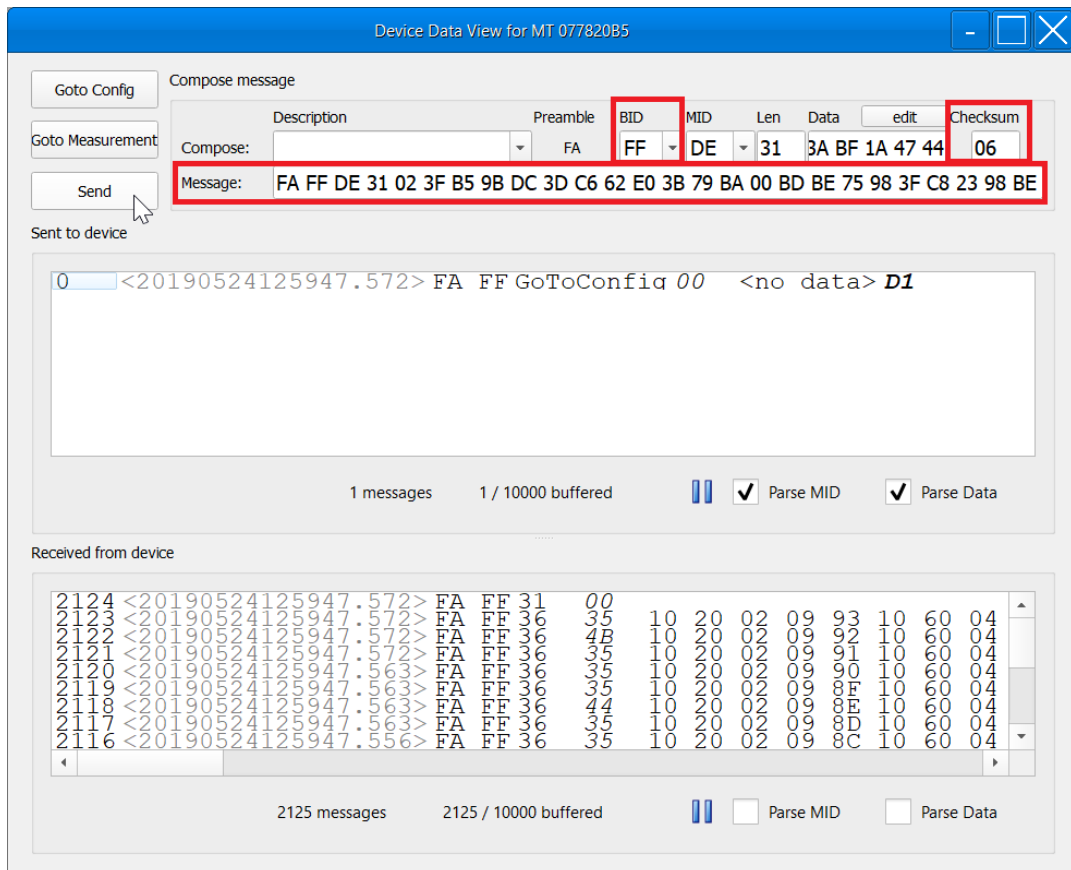

Figure 24: Sending an MFM results message using the Device Data View in MT Manager. Indicated are the calibration result message pasted in the Message box, the BusID (0xFF) and the Checksum (0x06).

Note:

- When communicating with the MTi over SPI or I²C interface, the MTi assumes a reduced Xbus message that starts with a default Preamble and BusID (0xFA 0xFF), see above screenshot. Depending on the Magnetic Field Mapper version, the calibration result message may instead contain an alternative BusID (e.g. 0x00 instead of 0xFF). As a result, the user may need to modify the calibration result message's BusID to 0xFF and update the checksum (CS). When pasting the message into the Device Data View of MT Manager, the correct checksum will automatically be calculated. For more information on the structure of reduced Xbus messages and how to determine a correct checksum, refer to the Low-Level Communication Protocol document (MT0101P).
 - The MTi is unavailable for communication for a short period after the calibration result message has been sent.
5. Upon receiving the message, the MT will update its non-volatile memory with the new calibration values. In MT Manager, you can verify this by comparing the calibration parameters in the MT Settings window, before and after writing the

calibration results. Disconnecting and reconnecting the device is necessary for MT Manager to update the calibration parameters.

Please note that performing a Revert command in MT Manager or RestoreFactoryDef low level command will restore factory defaults, including the magnetic calibration shipped from the factory. This provides a way to undo calibration uploaded to the sensor. In addition, it means that anytime the sensor is reverted to factory defaults, any new calibration values desired must be resent to the device.

4.3 Magnetic Field Mapping SDK

The Magnetic Field Mapping algorithm is also available in the Software Development Kit. This makes it possible to embed the Magnetic Field Mapping in 3rd party programs or to use MATLAB or C/C++/C#. The MFM SDK has the following components:

- DLL and .so that return MFM parameters and data for visualizations
- Examples for C#, MATLAB, C++

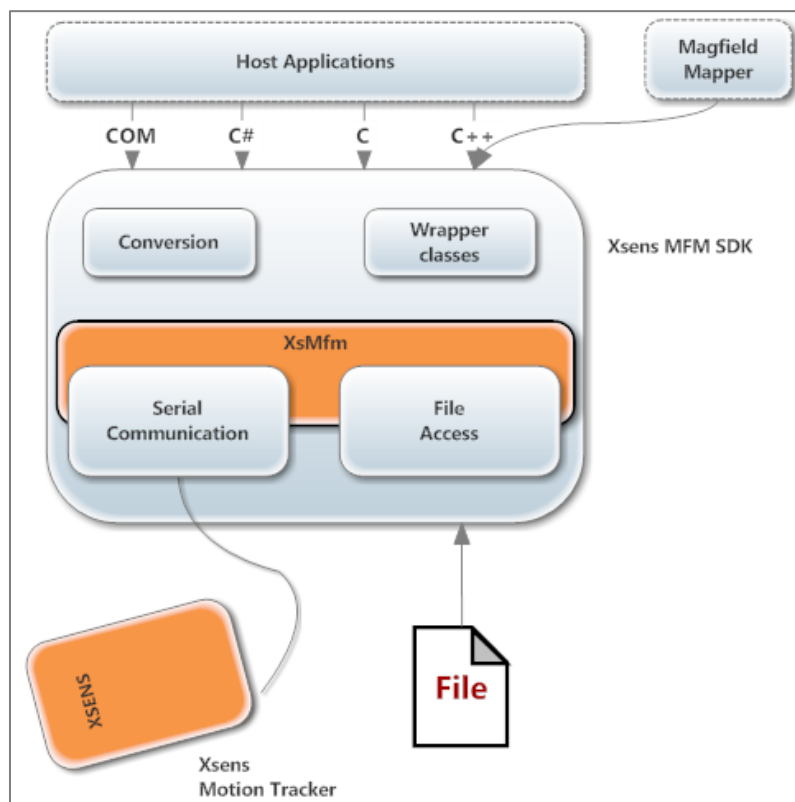

Figure 25: Structure of the MFM SDK

Note: Extensive HTML documentation for the MFM SDK is included in the SDK. See the Xsens folder (e.g. C:\Program Files\Xsens\MT Software Suite x.x\Documentation\MFM SDK)

4.4 In-Run Compass Calibration (ICC) and Representative Motion (RepMo)

Disclaimer: ICC and RepMo were first released with MT Software Suite 4.7 and are currently still in beta for all MT devices. These features are not available for MTw devices.



4.4.1 Representative Motion (RepMo)

Similar to the Magnetic Field Mapper, Representative Motion (RepMo) provides a solution to calibrate the sensor for magnetic distortions caused by objects that move with the MT. However, in contrast to the Magnetic Field Mapper, RepMo is a calibration tool that can run in the background of the onboard filters of the MT. A connection to a host computer is therefore not required.

When using "RepMo" the user should be careful that the calibration motion is performed in a homogeneous field (ideally, only the object attached to the sensor should distort the magnetic field). Exploiting the knowledge that the sensor is in a homogeneous environment, all magnetometer sensor data will be used for the calibration without any disturbance checks, speeding up the calibration process. Based on the sensor mounting, environment and application platform, the accuracy might vary. Users are encouraged to try this feature if they are aware of typical application dynamics and have a good knowledge of the environment of operation. This might be a valid option for trials that do not encounter any distortions in the environment such as (but not only) ships and airplanes.

4.4.2 How to enable Representative Motion

RepMo is disabled by default. The user can enable RepMo in various ways:

MT Manager	<p>In MT Manager, it is possible to stop and start the RepMo mode with this button:</p>  <p>After stopping the RepMo trial, if the calibration parameters are satisfactory, the newly generated ICC results can be stored to MT memory by clicking the corresponding icon:</p> 
Low Level Communication	<p>Both Starting/Stopping the RepMo mode and storing the ICC results can be done using <i>IccCommand</i>. Refer to the MT Low Level Communication Protocol Documentation for more information.</p>
XDA	

	<p>Start and Stop RepMo mode using <i>startRepresentativeMotion</i> and <i>stopRepresentativeMotion</i>. Store the ICC results using <i>storeIccResults</i>. Refer to the XDA library for more information: C:\Program Files\Xsens\MT Software Suite x.x\Documentation\MT SDK</p>
--	--

During the RepMo mode, the RepMo status bit in the Status Word will be 1. After stopping RepMo mode, an info dialog will come up (in MT Manager) or a feedback message will be sent by the filter (low-level communication and XDA), informing you about the results. It will tell you whether a 2D or 3D calibration was performed. For some applications, such as Ground Vehicles, a planar 2D calibration suffices. In addition, a score of the "Estimated distortion level" is returned. The closer the score is to 1, the better. Try performing multiple runs to see whether your results can be improved.

Although RepMo is designed to be used without a PC, we will demonstrate the use of RepMo using MT Manager in the following example.

The results of an MTi 1-series attached to a battery are shown in Figure 26. It is important to note that the magnetic norm (black line in the middle graph) should be constant if the sensor is properly calibrated and it is moving in a magnetically homogeneous environment. This is clearly not the case for the first part of the magnetometer signal. After the initial period of 13 seconds, Representation Motion is switched on for ~25 seconds. This is indicated by the (violet) status bit flag. The user then clicks the "Store In-Run Compass Calibration results" button in MT Manager to write the calibration results to the device memory. Once the results are written to the non-volatile memory, the magnetic calibration is applied and the magnetic field norm is nearly constant, showing a meaningful calibration done (for sensor-fixed distortions).

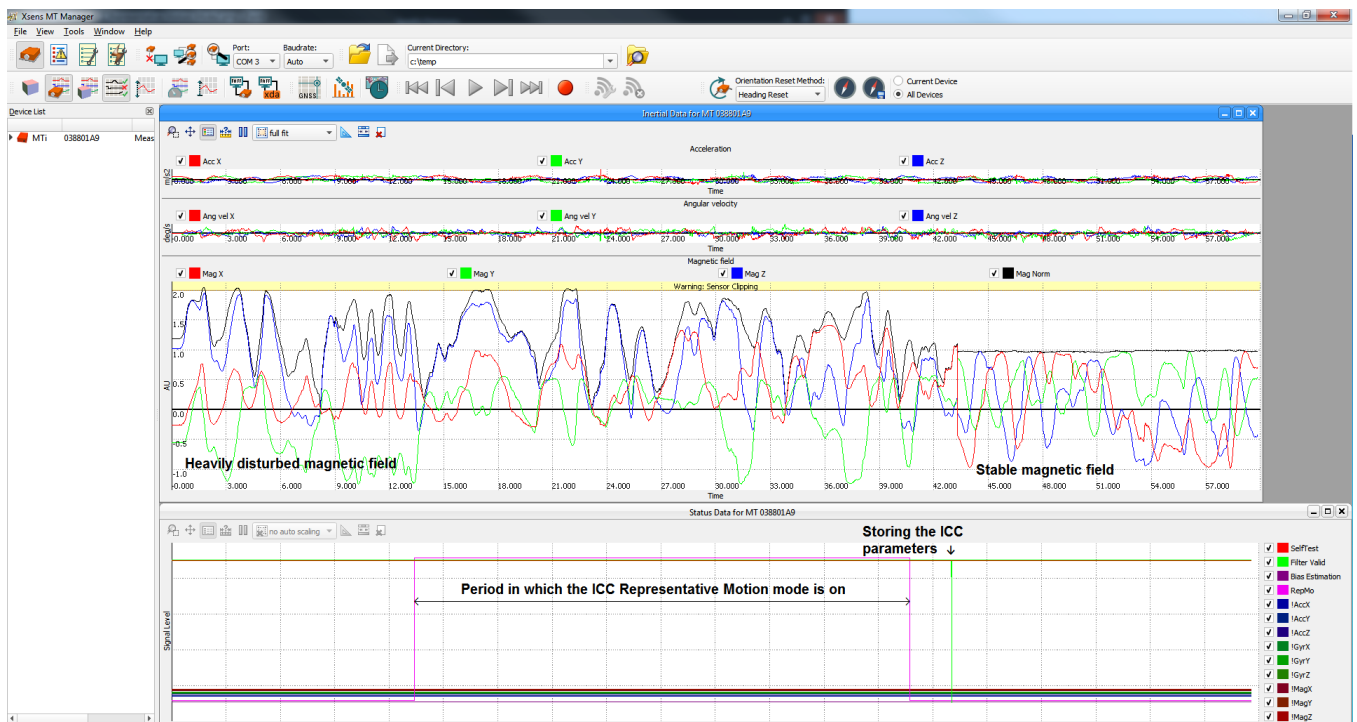

Figure 26: Effects of Representative Motion on magnetic field measurements.

4.4.3 In-Run Compass Calibration (ICC)

Similar to the Magnetic Field Mapper and Representative Motion, In-run Compass Calibration (ICC) provides a solution to calibrate the sensor for magnetic distortions caused by objects that move with the MTi. However, in contrast to the (single-run) Magnetic Field Mapper and Representative Motion, ICC is a feature that is continuously running in the background of the onboard filters of the MTi in order to improve magnetometer calibration for hard and soft iron effects.

ICC can be used as an alternative for, or in addition to a calibration performed by the Magnetic Field Mapper and Representative Motion. It results in a solution that can run embedded (leaving out the need for a host processor like a PC) and relies less on specific user input. The Magnetic Field Mapper, which does require a host processor, is however still recommended over or in addition to the ICC. The ICC feature is aimed at:



- Applications for which the MFM solution cannot be used (e.g. embedded MTi-1 series that cannot be connected to a PC);
- Applications for which a single MFM calibration is not sufficient (e.g. applications that move outside of the plane of motion used during the MFM calibration), or when the user uses the same MFM result performed for one sensor to calibrate different sensors (typical for large volume applications).

As a use case example, consider a scenario in which the MTi sensor is rigidly mounted on a car. The user can perform a MFM in a homogeneous environment by performing a circle with the car. Probably it would result in an almost 2D path (e.g. roll and pitch values <

10°). After that, the user can exploit the ICC feature to improve the calibration during the application. In this case, when the MTi reaches orientations that were not yet reached during the MFM (e.g. roll and pitch values > 10°), ICC will use this data to improve the magnetometer calibration.

4.4.4 How to enable ICC

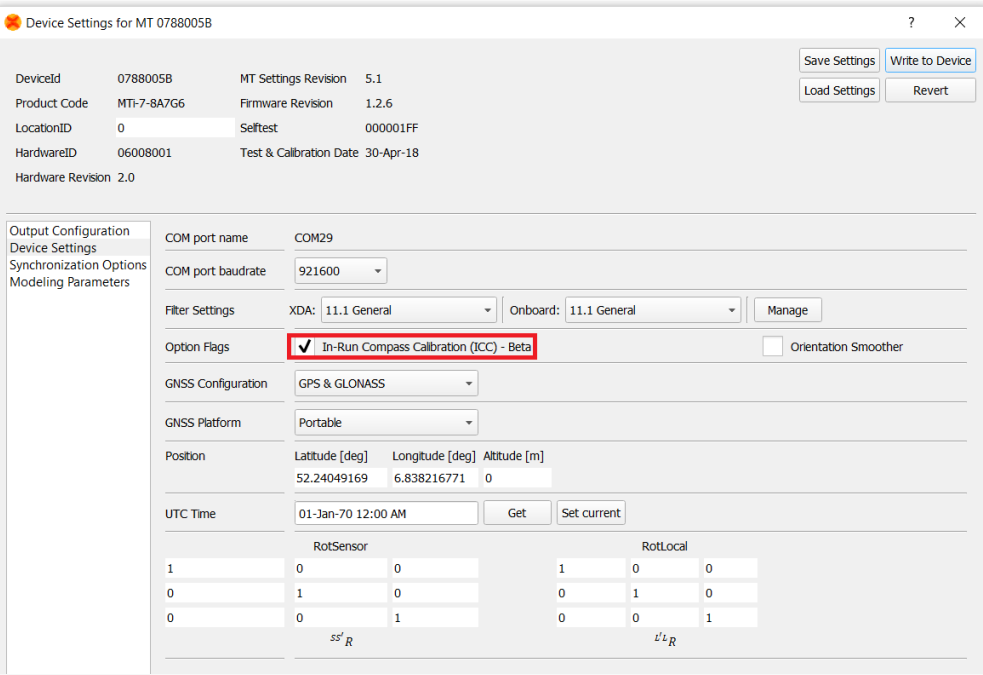
ICC is disabled by default. The user can enable ICC in various ways:

<p>MT Manager</p>	<ul style="list-style-type: none"> • Go to Device Settings → Device Settings. • Tick "In-Run Compass Calibration (ICC)". • Click "Write To MT".  <p>ICC is now continuously active in the background. After some time (several minutes minimum) the newly generated ICC results can be stored to MT memory by clicking the corresponding icon:</p> 
<p>Low Level Communication</p>	<p>Configure the device using the <i>SetOptionFlags</i> command. Store the ICC results using <i>IccCommand</i>. Refer to the MT Low Level Communication Protocol Documentation for more information.</p>
<p>XDA</p>	<p>Configure the device using <i>setDeviceOptionFlags</i>. Store the ICC results using <i>storeIccResults</i>. Refer to the XDA library for more information: C:\Program Files\Xsens\MT Software Suite x.x\Documentation\MT SDK</p>

4.4.5 Storing the ICC/RepMo parameters

Once the ICC parameters are estimated, either in RepMo mode or when ICC is running in the background, the calibration parameters can be stored to MT memory using the commands described in the previous paragraphs.

As soon as the command for storing the ICC results is sent to the MTi, the ICC/RepMo parameters and magnetometer calibration parameters will be copied from the RAM memory to the non-volatile memory where the previous calibration parameters will be updated. Note that if the connection with the MTi is lost before the calibration parameters are stored (e.g. by power cycling the MTi or rescanning in MT Manager), the updated calibration parameters will be lost.

The calibration parameters are estimated in background. The magnetometer readings shown in MT Manager are not compensated by the ICC/RepMo calibration results, unless these are stored in non-volatile memory (see Figure 27).

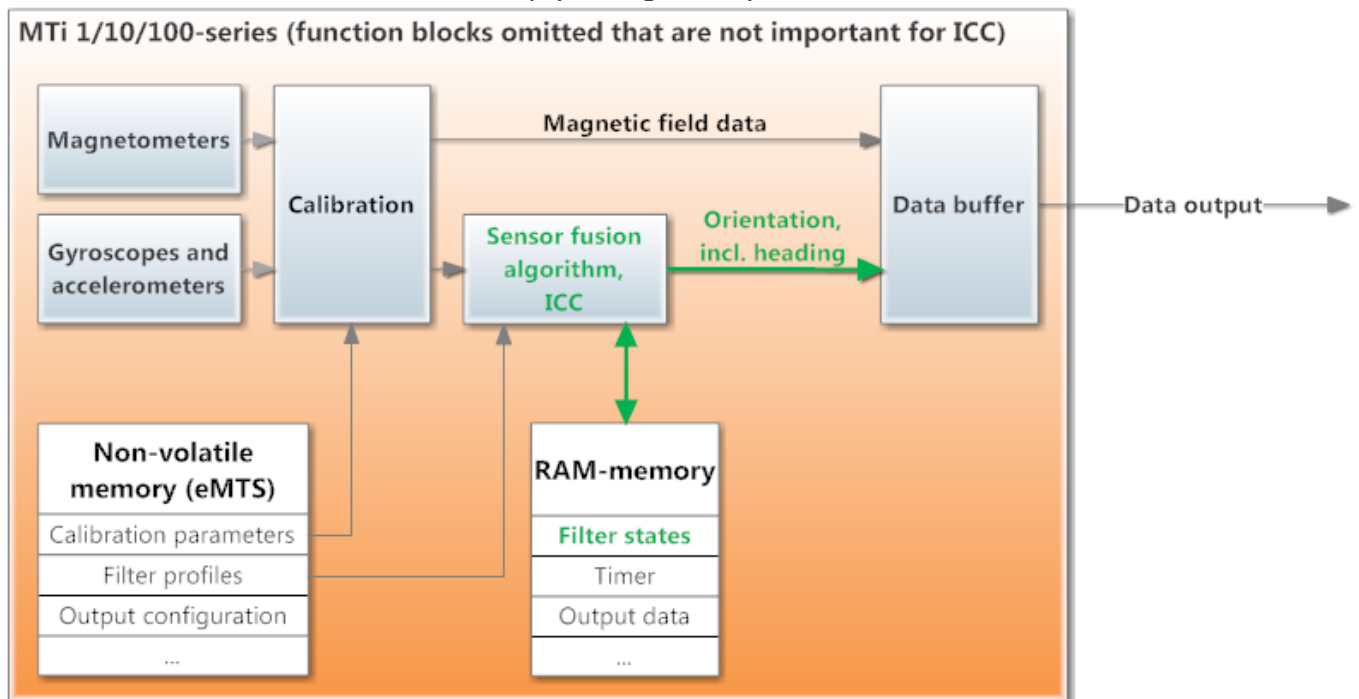

→ Includes ICC-compensation in sensor fusion

Figure 27: Data from the sensors (magnetometer and inertial sensors) are calibrated with the calibration parameters in the eMTS. The initial calibration parameters are a result of the factory calibration by Xsens. If ICC or the Representative Motion feature is on, filter states and compensation parameters are available in the RAM-memory. The magnetic field data (data output as shown in MT Manager) are not influenced by parameters in the RAM-memory.

Once stored (see Figure 28), the magnetometer measurements, calibrated with the new calibration parameters obtained by ICC/RepMo, can be observed in MT Manager.

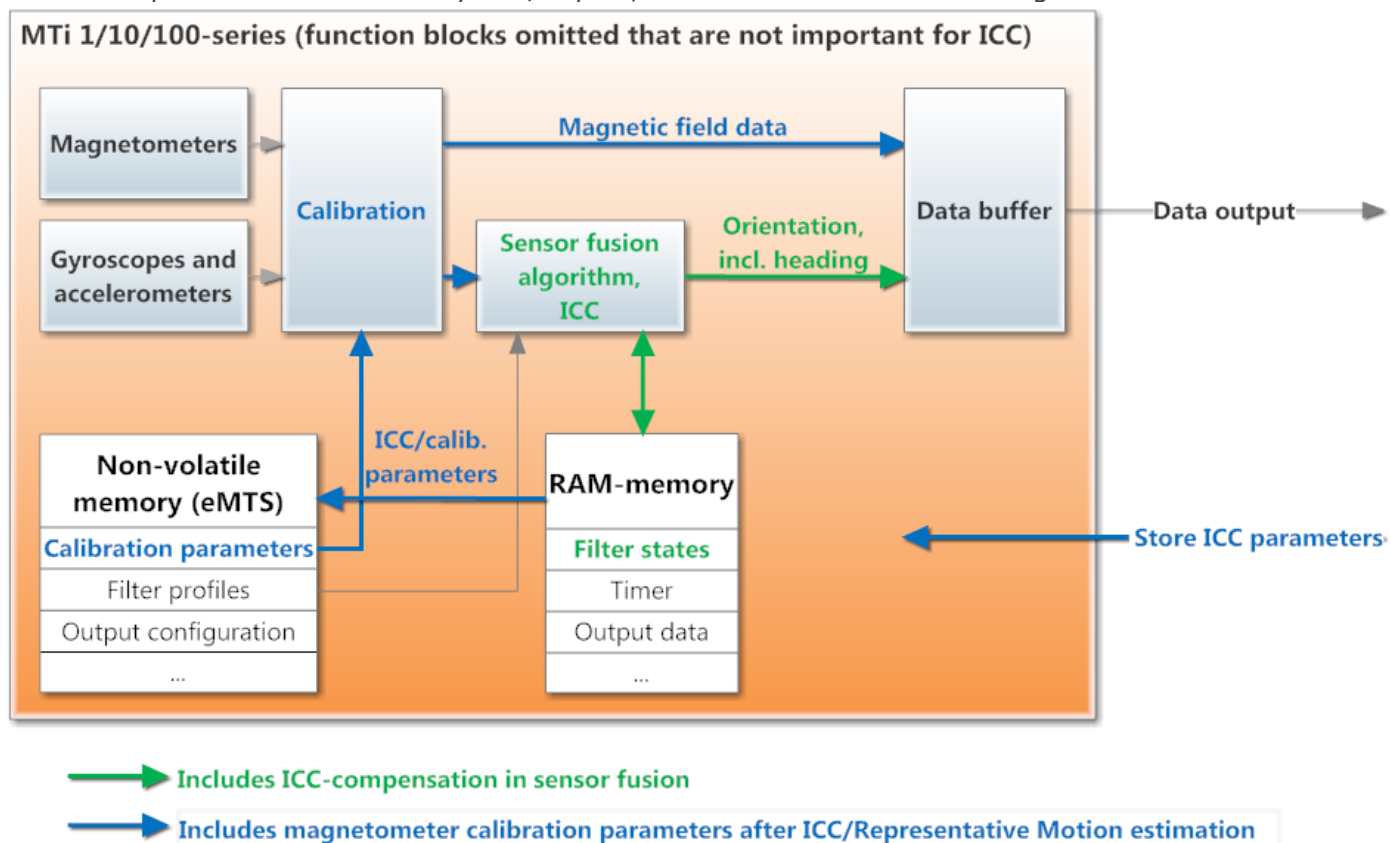

Figure 28: Once the command is given by the user to store the ICC calibration parameters, the MTi will write the parameters to the eMTS on the non-volatile memory. This way, the magnetometer sensor readings are calibrated with the ICC parameters before they are fed into the sensor fusion algorithm. Also, the magnetic field data will be outputted using the new calibration parameters.

ICC and RepMo are designed to be used embedded. However, it is possible to apply ICC and RepMo when processing log files offline. The ICC can be enabled in the MTi interface when opening a ".mtb" file. The user can start RepMo off-line only if the trial has been recorded with the "onboard processing" preset in Output configuration (i.e. orientation output is enabled in the output configuration. However, it is possible to tick the extra inertial data and magnetic field output).

4.4.6 Conclusion

The ICC/RepMo features are a useful alternative for calibrating for hard and soft iron effects when using the Magnetic Field Mapper (MFM) tool is not possible. When using ICC/RepMo, the newly obtained calibration measurements are immediately used in the sensor fusion algorithm. Once the calibration data are stored in non-volatile memory as well, the factory magnetometer calibration parameters will be overwritten, and magnetometer readings will be processed by the new calibration parameters. After

storing calibration parameters, ICC can remain enabled to run in the background and further improve parameter estimation.

6. Support – BASE by Xsens

Xsens has an extensive help center called BASE, a place where users of Xsens and Xsens employees (support, field application engineers, sales and R&D engineers) meet. The knowledge base contains tips and tricks, guidance and answers to frequently asked questions. News is also shared at the knowledge base and it is possible to ask additional questions.

The user community is the place to ask questions. Answers may be given by other users or by Xsens employees.

The knowledge base and user community are searchable simultaneously. A search query thus shows results irrespective of the source.

Please visit <https://base.xsens.com> to complete your 1-minute registration.